

Notice of Meeting and Meeting Agenda Integrated Waste Management Task Force

Friday, January 22, 2016

8:30 AM

Room 107

*V. Derman (Chair), K. Williams (Vice Chair), R. Atwell, A. Finall, C. Hamilton, L. Helps,
C. Plant, J. Ranns, G. Young, B. Desjardins (Ex-Officio)*

1. Approval of Agenda

2. Adoption of Minutes

2.1. 16-111 Minutes of January 15, 2016

Recommendation: That the minutes of January 15, 2016 meeting be adopted.

Attachments: [January 15, 2016 minutes.](#)

3. Chair's Remarks

4. Presentations/Delegations

5. Committee Business

5.1. 16-113 Revised Terms of Reference - Special Task Force on Integrated Resource Management

Recommendation: That the Task Force recommend to the Board that the revised Terms of Reference be approved.

Attachments: [Revised Terms of Reference](#)

5.2. 16-117 Inventory of Capital Regional District Waste Streams

Recommendation: That the Task Force receive the report, Inventory of Capital Regional District Waste Streams, for information.

Attachments: [Staff Report: Inventory of CRD Waste Streams](#)
[Appendix A: 2014 Detailed Summary of Waste Received at Hartland](#)

5.3. 16-114 Pivotal IRM Inc. Presentation

5.4. 16-116 Aqua-Tex Scientific Consulting Ltd. Report: Resources from Waste - Integrated Resource Management Phase I Study Report

Attachments: [Resources from Waste - Integrated Resource Management Phase 1 Study Rep](#)

5.5. 16-115 Motions approved by CRD Board regarding pilot projects

Attachments: [Motions Regarding Pilot Projects](#)

6. New Business

7. Adjournment

Next Meeting: January 29, 2016, 8:30 a.m.



Making a difference...together

**Minutes of a Meeting of the Special Task Force on Integrated Resource Management
Held January 15, 2016 in the Board Room, 625 Fisgard St., Victoria, BC**

PRESENT: **Directors:** B. Desjardins (Board Chair, 8:36), R. Atwell, V. Derman, A. Finall, C. Plant, J. Ranns, K. Williams
Staff: L. Hutcheson, General Manager, Parks & Environmental Services, D. Dionne, Recording Secretary
ABSENT: **Director:** C. Hamilton, L. Helps, G. Young

The meeting was called to order at 8:33 a.m. Agenda Item 1, Board Chair's Remarks, was delayed and the meeting moved to Agenda Item 2, Election of Chair.

1. Election of Chair

Nominations were called for election of chair for the Special Task Force on Integrated Resource Management for 2016. Director Derman was nominated and agreed to stand. There were no further nominations. Director Derman was proclaimed as chair.

2. Election of Vice Chair

Nominations were called for election of vice chair for the Special Task Force on Integrated Resource Management for 2016. Director Williams was nominated and agreed to stand. There were no further nominations. Director Williams was proclaimed as vice chair.

3. Approval of Agenda

MOVED by Director Finall, **SECONDED** by Director Williams,
That the agenda be approved as circulated.

CARRIED

4. Chair's Remarks

Chair Derman noted that the Capital Regional District (CRD) is looking at making major investments in resource management and this task force is well positioned to facilitate recommendations to move forward.

He also noted that:

- The CRD Board is looking more closely at climate change and this committee will need to ensure that this is taken into consideration.
- The CRD Board is seeking a report from this committee by the end of February.

8:36 a.m. B. Desjardins joined the meeting

5. Board Chair's Remarks

Board Chair Desjardins thanked the group for meeting and noted the following:

- This task force established to provide recommendations to the CRD Board for moving forward with integrated resource management (IRM) for the region.

- The Board is seeking input on the following:
 - What does IRM mean to the CRD?
 - Governance is a concern in decision making; a combined decision is needed in order to move forward, and therefore a review of the governance structure may be required.
 - Recommendations for proceeding.

6. Terms of Reference

It was noted that the Board had determined the end of February as a deadline, and it was recognized that this is a tight timeline.

Discussion ensued with the following points raised:

- Engaging a consultant will extend the timeline beyond the end of February.
- There is a need to develop solutions prior to engaging a consultant.
- The committee would like to hear from expert groups, such as the Pivotal, to help form its recommendations.
- The committee could recommend the RFP process, but designing it is administrative and could result in a delay to the timeline.
- The group asked staff to provide them with a copy of the 2008 Fidelis report on IRM to review for its next meeting – noting that there are provincial recommendations within that report that need to be reviewed and addressed
- There is a need to define scope and parameters before making recommendations to the Board
- It was noted that there is also the ability to conduct a pilot

MOVED by Director Finall, **SECONDED** by Director Williams,
That the Terms of Reference be amended as follows:'

CARRIED

Page 1, Item 1.0 Purpose, bullet two under Committee to, rewrite as:

Recommend to the Board to develop and recommend a process for broadly seeking submissions from the private sector and to implement the recommended initiative.

Page 1, Item 1.0 Purpose, bullet three under Committee to, strike “top 3-6”.

Page 1, Item 1.0 Purpose, bullet four under Committee to, strike entirely.

Page 1, Item 2.0 Establishment and Authority, replace bullet three with:

Recommend to the Board a process for implementing the recommendations of the Committee.

The discussion moved to Agenda Item 10, Next Meeting.

7. Next Meeting

The committee agreed to meet weekly on Fridays at 8:30 a.m. The next meeting will be January 22. It was also agreed that due to the short timelines between meetings, materials could be received by email as soon as they are available instead of waiting to receive them at the next meeting.

9:23 a.m. B. Desjardins left the meeting

8. Committee Business

8.1 Integrated Resource Management Workshop Report – October 7, 2015

L. Hutcheson spoke to the report noting that it was included in the agenda package as background and reference for the committee.

MOVED by Director Ranns, **SECONDED** by Director Williams,
That the Integrated Resource Management Workshop Report – October 7, 2015, be received for information.

CARRIED

Discussion ensued with the following points noted:

- The committee agreed that pages 2 to 6 of the report are useful for framing decisions and recommendations.
- It was noted that there is a motion from the Environmental Services Committee for a pilot to be conducted. This motion will be on the next agenda for discussion.

9. New Business

Chair Derman put forward items for the next agenda and asked members to email any other agenda recommendations prior to Tuesday, January 19, 2016.

Items identified:

- 2008 Integrated Resource Management report
- Motions from the Environmental Services Committee and Saanich Peninsula Wastewater Commission regarding the kitchen scraps and biosolids pilots
- Invite groups to speak at upcoming meetings. Groups that have spoken to the Westside Wastewater Treatment and Resource Recovery Select Committee and the Technical Oversight Panel
- The committee requested an information report that identifies the region's feedstock, including material from Sooke, municipal solid waste and other potential sources.

10. Adjournment

MOVED by Director Plant, **SECONDED** by Director Atwell,
That the meeting be adjourned at 9:48 a.m.

CARRIED

CHAIR

RECORDER

Terms of Reference

CRD

SPECIAL TASK FORCE ON INTEGRATED RESOURCE MANAGEMENT

TERMS OF REFERENCE

PREAMBLE

The Capital Regional District (CRD) Special Task Force on Integrated Resource Management is a select committee (Committee) established by the CRD Board and will examine options for integrated resource management of liquid and solid wastes.

The official name is to be:

CRD Special Task Force on Integrated Resource Management

1.0 PURPOSE

- To hold discussions about Integrated Resource Management
- Committee to:
 - define scope and parameters of Integrated Resource Management objectives
 - ~~work within CRD procurement policy to engage a technical consultant to review and evaluate potential solutions to achieve objectives recommend to the Board to develop and recommend a process for broadly seeking submissions from the private sector and to implement the recommended initiative~~
 - recommend ~~top 3-6~~ options to the Board endorsement
 - ~~develop Request for Proposals for feasibility/technical evaluation~~

2.0 ESTABLISHMENT AND AUTHORITY

- The Committee will make recommendations to the Board, for consideration;
- The Board Chair will appoint the Committee Chair and Committee members; and
- ~~It is expected the Committee will cease to exist once it has reported its findings and recommendations to the Board. Recommend to the Board a process for implementing the recommendations of the Committee.~~

3.0 COMPOSITION

- Committee members will be CRD Directors and CRD Staff

- The CRD Board Chair is an ex-officio member of the Committee.

4.0 PROCEDURES

- The Committee shall meet at the call of the Committee Chair; and
- The Committee Chair shall determine the agenda or meetings, and any Committee member may request that a matter be placed on the agenda.
- At the request of a Committee member and with the consent of the Committee Chair guests or delegations may be invited to attend and participate in the meeting.

5.0 RESOURCES AND SUPPORT

- The General Manager, Parks and Environmental Services will provide strategic support and act as a liaison
- Minutes and agendas are prepared and distributed by the Environmental Resource Management Division.
- The Environmental Resource Management Division will provide additional administrative support as required.



Making a difference...together

**REPORT TO
SPECIAL TASK FORCE ON INTEGRATED RESOURCE MANAGEMENT
MEETING OF FRIDAY, JANUARY 22, 2016**

SUBJECT **Inventory of Capital Regional District Waste Streams**

ISSUE

To provide requested information regarding a summary of waste in the Region.

BACKGROUND

A detailed summary of waste streams in 2014 is attached for your information (Appendix A). A total of 175,000 tonnes of waste was received at Hartland and Tervita landfills in 2014:

Type of Waste	Total Tonnage	Muni/CRD Tonnage
General Refuse	141,806	33,364
Controlled Waste (solid)	2,423	83
Controlled Waste (liquid)	6,318	5,336
Diversion (blue box/depot)	26,748	6,157
TOTAL	177,331	44,940

There was a 3% reduction (3,800 tonnes) in total waste received by the Hartland landfill in 2015. A detailed 2015 Hartland waste summary has not been compiled yet, but should be ready in early February.

Controlled liquid waste disposed at Hartland has varying liquid contents depending on the producer.

There is additional municipal yard and garden and food waste feedstock that is being diverted but is not brought through Hartland or Tervita, therefore not quantified in this report. Conservative estimates indicate additional municipal feedstock of 18,000 tonnes of yard and garden waste and 6,000 tonnes of food waste. Individual municipalities are being contacted for this information and confirmed tonnage figures will be brought to the Task Force once compiled.

Residential recycling materials, blue box and depot, have been added to the table. Most of these materials are part of approved provincial stewardship programs and are likely not available to divert from current programs.

The Capital Regional District (CRD) does not track the flow of waste in or out of the region. Based on relationships with local waste haulers it is assumed that some waste is exported to the lower mainland to take advantage of lower tipping fees. In addition, the CRD likely receives some waste from the Cowichan Valley Regional District, as haulers attempt to minimize their costs. Overall waste trends, by hauler, do not seem to indicate any significant change in disposal behaviour over the last five years.

RECOMMENDATION

That the Special Task Force on Integrated Resource Management:

Receive report, *Inventory of Capital Regional District Waste Streams*, for information.

Submitted by:	Russ Smith, Senior Manager, Environmental Resource Management
Concurrence:	Larisa Hutcheson, P.Eng., General Manager, Parks & Environmental Services

RS:dd

Attachments: Appendix A - 2014 Detailed Summary of Waste Received at Hartland

MATERIAL SUMMARY

				GOVERNMENT CONTROLLED FEEDSTOCK
MATERIAL	COLLECTION	CONTROLLER	TONNAGE	
DISPOSAL				
HAULER				
General Refuse ⁽¹⁾				
paper and paperboard	municipalities, private, self haul bus and res	30% gov't, 70% other	21,888	6,566
food waste	municipalities, private, self haul bus and res	30% gov't, 70% other	19,709	5,913
plastic	municipalities, private, self haul bus and res	30% gov't, 70% other	17,312	5,194
wood and wood products	municipalities, private, self haul bus and res	30% gov't, 70% other	13,133	3,940
construction and demolition	private, self haul bus and res	100% other	30,594	-
textiles	municipalities, private, self haul bus and res	30% gov't, 70% other	7,287	2,186
composite materials	municipalities, private, self haul bus and res	30% gov't, 70% other	6,851	2,055
other	municipalities, private, self haul bus and res	30% gov't, 70% other	6,441	1,932
yard waste	municipalities, private, self haul bus and res	30% gov't, 70% other	4,430	1,329
other organic waste	municipalities, private, self haul bus and res	30% gov't, 70% other	3,134	940
ferrous metals	municipalities, private, self haul bus and res	30% gov't, 70% other	3,134	940
glass	municipalities, private, self haul bus and res	30% gov't, 70% other	2,566	770
electronics	municipalities, private, self haul bus and res	30% gov't, 70% other	2,526	758
hazardous waste	municipalities, private, self haul bus and res	30% gov't, 70% other	1,017	305
rubber	municipalities, private, self haul bus and res	30% gov't, 70% other	939	282
non-ferrous metals	municipalities, private, self haul bus and res	30% gov't, 70% other	845	254
			141,806	33,364
Controlled Waste (solid waste)				
waste asbestos	municipalities, private, self haul bus and res	100% other	1,390	-
surface coating waste	municipalities, private haulers	100% other	265	-
out of region asbestos	municipalities, private, self haul bus and res	100% other	182	-
contaminated soil	municipalities, private, self haul bus and res	100% other	151	-
food processing waste	municipalities, private haulers	100% other	148	-
spoiled food	municipalities, private, self haul bus and res	100% other	112	-
misc controlled waste	municipalities, private, self haul bus and res	92% gov't, 8% other	56	52
dead animals	municipalities, private, self haul bus and res	86% gov't, 14% other	37	32
animal fecal waste	municipalities, private, self haul bus and res	100% other	34	-
soot and spent charcoal	private haulers, residents, self haul bus	100% other	24	-
health hazard waste	municipalities, private haulers	100% other	22	-
contaminated drywall	municipalities, private, self haul bus and res	100% other	2	-
			2,423	83
Controlled Waste (liquid waste)				
SPWWTP (screenings/sludge)	CRD contractors or staff	100 % gov't	3,601	3,601
Other sludge	private haulers	100% other	675	-
Pumpings (non sewage)	municipalities, private, CRD contractors/staff	70% gov't, 30% other	611	428
Sooke (screenings/sludge)	CRD contractors or staff	100 % gov't	580	580
Clover Point (screenings)	CRD contractors or staff	100 % gov't	392	392
Macaulay Point (screenings)	CRD contractors or staff	100 % gov't	318	318
Other screenings	private haulers	100% other	124	-
Tsawout (screenings/sludge)	private haulers	100 % gov't	17	17
			6,318	5,336
TOTAL DISPOSAL 2014			150,547	38,783

MATERIAL SUMMARY CONTINUED

				GOVERNMENT CONTROLLED FEEDSTOCK
MATERIAL	COLLECTION	CONTROLLER	TONNAGE	
DIVERSION ⁽²⁾				
RECEIVER				
Paper Fibres	CRD contractors and facilities	100% other (stewards)	14,319	-
Mixed Containers ⁽³⁾	CRD contractors and facilities	100% other (stewards)	5,408	-
Asphalt Shingles	CRD facilities	100% gov't	803	803
Batteries	CRD facilities	100% other (stewards)	40	-
Books	CRD facilities	100% gov't	42	42
Electronics	CRD contractors and facilities	100% other (stewards)	364	-
HHW Orphans	CRD facilities	100% gov't	63	63
Mattresses	CRD facilities	100% gov't	189	189
Metals	CRD facilities	100% gov't	591	591
Metal Appliances	CRD facilities	100% other (stewards)	131	-
Motor Oil, Filters, Containers	CRD contractors and facilities	100% other (stewards)	37	-
Plastic (Large Rigid)	CRD contractors and facilities	100% gov't	158	158
Plastic (Film)	CRD contractors and facilities	100% other (stewards)	33	-
Paint/Pesticides/Lamps	CRD facilities	100% other (stewards)	166	-
Propane Tanks/Fire Ext.	CRD facilities	100% gov't	20	20
Polystyrene	CRD contractors and facilities	100% other (stewards)	27	-
Tires	CRD contractors and facilities	100% other (stewards)	55	-
Toilets	CRD facilities	100% gov't	7	7
Wood Waste	CRD facilities	100% gov't	1,432	1,432
Food Waste	Municipalities	100% gov't	2,185	2,185
Yard Waste	CRD Facilities	100% gov't	620	620
Miscellaneous ⁽⁴⁾	CRD contractors and facilities	50% gov't, 50% stewards	94	47
TOTAL DIVERSION 2013			26,784	6,157
GRAND TOTAL ALL MATERIAL STREAMS			177,331	44,940

⁽¹⁾ General refuse tonnage by material type is an estimate based on known kitchen scraps diversion and latest waste stream analysis data. Data includes 22,500 tonnes of construction and demolition waste from Tervita Highwest Landfill in Highlands.

⁽²⁾ 2013 data-Quantity of curbside paper fibres/mixed containers not available with material being managed under stewardship beginning May 2014

⁽³⁾ Estimated composition by weight = 40% glass, balance is a mixture of plastic, metal and polycoat containers

⁽⁴⁾ Cooking oil, reusable goods, milk cartons, deposit containers, polycoat containers

Resources from Waste

Integrated Resource Management Phase I Study Report

Prepared for:

BC Ministry of Community Services

29 February, 2008



Mr. Dale Wall
Deputy Minister
Ministry of Community Services
PO Box 9490 Stn Prov Govt
Victoria BC V8W 9N7

February 29, 2008



RESOURCES FROM WASTE – PHASE I STUDY REPORT

Dear Mr. Wall,

The Study Team has the pleasure of submitting its final report. The Study Team has analysed in detail the responses to the reviews provided by the Technical Advisory Committee and the four peer reviewers commissioned by the Steering Committee. These reviews have provided information which is of benefit both to the Study Team and the government as it proceeds to implement IRM as recommended in the report. The Study Team notes that in all cases the reviewers concluded that IRM should be “supported and implemented”:

‘I conclude that IRM is conceptually sound, on the right track and if implemented would likely prove a model of great value to the countless municipalities throughout the world’.—Dr. Charles Mc Neill

‘There is general agreement by the Technical Advisory Committee members that the IRM approach should be supported and implemented and that the study has highlighted some real possibilities for local governments to consider.’—Technical Advisory Committee

‘The IRM program as presented is a true paradigm shift in handling wastewater and offers numerous interesting concepts to capture energy, generate need revenue and reduce the carbon footprint. The concepts are absolutely intriguing and suitable for further study’.—Lewis and Zimmerman

‘The IRM concept for integrating solid and liquid waste management planning and development infrastructure is a very good process and components of it should be implemented over an adequate time schedule. There are significant energy recoveries; heat and electricity, and greenhouse gas reductions available, particularly on the solid waste and bio-solids side.’—Dr. Bob Dawson

Where appropriate, the Study Team has incorporated some of the responses to these reviews into the final report. More detailed responses are included in a commentary attached to this report. In many cases the comments will need to be considered in the implementation of IRM.

In the words of Dr. Charles McNeill, United Nations: *‘I am not surprised that this kind of important and innovative exercise would be undertaken in BC in view of the Province’s growing reputation worldwide and its local track record of leadership in sustainability issues’*. The Study Team agrees that IRM supports the new initiative called ‘LiveSmart BC’ outlined in the 2008 Throne Speech and has the potential to make major contributions to the provincial climate action plan and associated policies for energy conservation, bio-energy strategy and the forthcoming plan for water management also announced in the 2008 Throne Speech. We are pleased to have been given the opportunity to work with the Steering Committee and Technical Advisory Committee on this important initiative.

Yours truly,

The IRM Study Team

Table of Contents

Executive Summary and Key Recommendations iv	
IRM Infrastructure.....vii	Provincial Government Goals and Policies.....77
Summary of the Capital Region Example.....viii	CRD Goals and Policies.....82
Implementation Strategy.....x	Municipal Goals and Policies84
Conclusionsxii	Appendix D: Waste Treatment Technologies..... 87
Recommendationsxiv	The Treatment Process.....87
Introduction 2	Appendix E: Water Conservation and Recovery 95
Purpose and Scope.....2	Closed-loop Water Systems95
Report Structure.....3	Reuse of Water for Surface and Groundwater Recharge96
Authors and Contributors.....4	Reduction in Demand for Potable Water97
Traditional Waste Management 5	Water and Climate Change102
The Integrated Resource Management Approach 7	Appendix F: Energy Recovery..... 104
Vision and Principles.....10	Energy Capture: District Heating & Cooling.....104
Unique Features of IRM14	Challenges Facing District Heating and Cooling110
Role for IRM in British Columbia.....16	Anaerobic Digestion for Biogas.....111
IRM Policy Comparison19	Gasification for Syngas.....113
Resource Recovery Technology and Opportunities21	Recovery of Metals.....115
Treatment Technology.....21	Appendix G: Valuation Methodology 119
Resource Recovery21	Background on Standards120
IRM Implementation Strategy26	Frameworks & Processes.....122
Capital Region Example29	Approaches to Value.....123
Sewage Treatment in the Capital Region.....29	Highest and Best Use & Value126
Wastewater Treatment Infrastructure.....30	Carbon Price127
Energy and Water Recovery from Wastewater Treatment.....31	Appendix H: Business Case..... 130
Capital Region Business Case Summary37	Overview130
The Business Case for IRM in British Columbia47	Paying for Sewage Treatment.....135
Potential Benefits of an IRM Approach.....47	Process & Principles Used.....136
Potential Challenges of an IRM Approach49	Financial Analysis.....137
Government Role, Procurement & Management Change55	Environmental Analysis.....141
Conclusions56	Social Analysis141
Recommendations58	Sensitivity Analysis142
References63	Scenario Analysis144
Glossary of Terms68	Business Case Risk Analysis146
Appendix A: Project Scope71	Appendix I: Reviews and Comments 149
Appendix B: Authors, Contributors and Reviewers72	Synopsis of Expert Review Comments.....149
Authors' Backgrounds.....74	General Comments150
Appendix C: Government Policies and Commitments76	Merits of IRM.....150
Federal Government Goals and Policies.....76	Weaknesses of the Draft Report.....151
	Suggested Additions151
	Questions to be Addressed in Next Phase.....152
	Research Needs.....154
	Overall Conclusions.....154
	Appendix J: Aspects for Further Study 157
	Governance Structure157
	Barriers to Implementation157
	Sewage Treatment Options158
	District Heating and Cooling159
	Energy Generation from Organic and Other Wastes.....160
	Value, Business Case & Economic161

List of Tables

<p>Table 1: How IRM Differs from Traditional Waste Management vi</p> <p>Table 2: Financial Summary, Capital Region IRM ix</p> <p>Table 3: IRM Implementation Values and Risks xi</p> <p>Table 4: Resource Recovery Examples 8</p> <p>Table 5: Potential District Energy Winter Loads in the Capital Region 33</p> <p>Table 6: Potential District Energy Summer Loads in the Capital Region 34</p> <p>Table 7: Potential Sites for Water and Waste Recovery in the Capital Region 35</p> <p>Table 8: Financial Summary, Capital Region IRM 38</p>	<p>Table 9: Annual GHG Emissions Projections, Capital Region 42</p> <p>Table 10: Uses of Reclaimed Water 98</p> <p>Table 11: Components of Municipal Waste and Their Potential Uses 116</p> <p>Table 12: Demand, Influent & Population Analysis 133</p> <p>Table 13: Average Fuel Price Trend Projections 135</p> <p>Table 14: WERC Cost Analysis 139</p> <p>Table 15: Sensitivity Table 143</p> <p>Table 16: Preliminary Scenario Analysis, Capital Region 145</p> <p>Table 17: Preliminary risk assessment 146</p>
--	--

List of Figures

<p>Figure 1: IRM Concept Diagram viii</p> <p>Figure 2: Thorsø Biogas Plant, Denmark 7</p> <p>Figure 3: IRM Concept Diagram 9</p> <p>Figure 4: Highest and Best Use Matrix for Organic Solid Waste 15</p> <p>Figure 5: Highest and Best Use Matrix for Reclaimed Water 16</p> <p>Figure 6: District Heating Loop in Gothenburg, Sweden 17</p> <p>Figure 7: Biogas Powered Bus in Sweden 18</p> <p>Figure 8: District Heating & Cooling Loops 24</p> <p>Figure 9: Building Heating & Cooling Distribution 24</p> <p>Figure 10: Possible Load for Capital Region IRM Treatment Plants 30</p> <p>Figure 11: Lonsdale Energy Corp. District Loop Illustration 31</p> <p>Figure 12: Heat Pump at Pacific Sands Resort, Parksville 32</p>	<p>Figure 13: Water and Energy Recovery Cell (WERC) concept diagram for James Bay and Legislature Precinct 37</p> <p>Figure 14: Capital Region Financial Summary Graphs 39</p> <p>Figure 15: The proportion of revenue from each source on a “total cash” approach, which takes into account the capital, financing, operating and maintenance costs of infrastructure required to produce each revenue stream 41</p> <p>Figure 16: Biogas Plant in Kristianstad, Sweden 51</p> <p>Figure 17: Treated Wastewater Quality Objectives 89</p> <p>Figure 18: Water Reclamation Station Schematic 91</p> <p>Figure 19: Sooke Reservoir. CRD Photo 97</p> <p>Figure 20: Shadow Price of Carbon 128</p> <p>Figure 21: Energy Price Trends, 1990-2007 134</p>
--	---

Disclaimer

The information presented in this document was compiled and interpreted exclusively for the purposes of determining whether there is a preliminary business case for a more sustainable and integrated approach to wastewater management and integrated resource recovery for communities, especially in British Columbia, and whether it is worthy of further investigation. The IRM Study Team has prepared this document at the request of the Government of British Columbia, solely for the purpose noted above.

The IRM Study Team and other contributors to this report have exercised reasonable skill, care and diligence to assess the information acquired during the preparation of this report, but make no guarantees or warranties as to the accuracy or completeness of this information, which is specific for the original purposes intended. This document, the information contained herein, information and basis on which it relies and factors associated with implementation and application are subject to change that are beyond the control of the authors. The document is thus based upon, and limited by, the circumstances and conditions acknowledged herein, and upon information available at the time of its preparation. The information provided by others is believed to be accurate, but has not been verified.

IRM Study Team does not accept any responsibility for the use of this report for any purpose other than that stated above and does not accept responsibility to any third party for the use, in whole or in part, of the contents of this document. This report is intended to provide a general preliminary assessment of the potential for IRM and expressly cannot be applied to a specific instance without adjustment and considerable further analysis. Any use by the Province, its sub-consultants or any third party, or any reliance on or decisions based on this document, are the responsibility of the user or third party.

The IRM Study Team jointly and severally transferred copyright of this document to the Province of British Columbia as an entire and cohesive whole and this document must be retained as a cohesive whole in accordance with the contract signed on December 7, 2007 between the Province and Aqua-Tex Scientific Consulting.

IRM Study Team (the authors):

- Chris Corps, B.Sc., MRICS, Asset Strategies Ltd.
- Stephen Salter, PEng, Farallon Consultants Ltd.
- Wm. Patrick Lucey, M.Sc., R.P. Bio., Aqua-Tex Scientific Consulting Ltd.
- Jon O'Riordan, Ph.D.

© Province of British Columbia, 2008.

Executive Summary and Key Recommendations

Imagine a future where human activities enhance our environment, clean our water, reverse the growth of greenhouse gases and create diverse, active and healthy communities. We can do this, but it's going to take a sea change in behaviour. As Einstein so clearly stated, the world will not evolve past its current state of crisis by using the same thinking that created the situation. This requires us all to think and to act differently, and that's the challenge."

Premier Gordon Campbell – UBCM Convention September 28, 2007

Integrated Resource Management (IRM) of municipal waste streams and water systems represents a new way of thinking. This IRM study arose from discussions with senior levels of the British Columbia government in June and July 2007. The request from the Province was to develop a conceptual design for the application of IRM in the province and to analyse its potential contribution to the provincial climate change agenda. This agenda is laid out in the provincial government's 2007 and 2008 Throne Speeches, the address by the Premier to the UBCM convention in 2007, the 2008 Provincial Budget, as well as commitments made in the Western Climate Initiative and the BC Energy Plan.

The first part of the report evaluates the potential application of IRM across the Province. The model has the capacity to be applied to all communities in British Columbia and indeed communities across Canada and the United States, though the specifics of the application will vary depending on the size of communities and the nature of their existing infrastructure. As the Capital Regional District (CRD) had been comprehensively reviewing its Liquid Waste Management Plan in response to a July 21, 2006 directive from the Minister of Environment, the Province and the CRD requested that the Capital Region be used as an example to test the concepts used in the IRM approach. The Capital Regional District received subsequent direction from the Minister of Environment on December 14, 2007 to 'maximize beneficial reuse of resources and generation of offsetting revenue'. It should be emphasised that it is not appropriate to compare the work undertaken in this report with the studies commissioned by the CRD on wastewater treatment prior to the Minister's letter of direction, as:

- The design and cost estimates in the CRD study arose from a need to achieve regulatory compliance with a ministerial order, within an existing operating structure. This approach emphasises determining a least-cost design required to meet regulatory waste discharge standards, with resource recovery as a final consideration. IRM approaches the problem of waste management from a perspective of maximising resources and value based on the principles of industrial ecology with the ultimate goal of zero waste. These two approaches are fundamentally different;

- The IRM study considered treatment design and costs only from generalised data sources, whereas the CRD analysis has considerably greater detail on costs. The peer reviews clearly identified that more analysis is required to determine the costs of waste treatment and resource recovery, so there is a different level of risk, certainty and detail between the IRM and CRD analyses;
- The CRD study assessed the cost of liquid waste infrastructure but the Minister of Environment's direction is now to analyse revenues and 'to aggressively pursue options to...reduce greenhouse gas emissions' (GHGs). The IRM model already builds into the model a range of options to reduce GHGs.
- The CRD study had not yet included an analysis of resource recovery potential in its evaluation (but is now required to do so), whereas the IRM study uses revenues as the driver; and
- The CRD approach chose to design its infrastructure now to meet long-term demand, whereas the IRM approach facilitates an incremental approach, with consequent differences in debt finance, debt carry, infrastructure dependence and cost.

Integrated Resource Management (IRM) contains the following elements:

- IRM uses a *process* of structured analysis of options within a business case model that includes environmental aspects (GHGs, carbon taxes and credits, energy, etc.). Each option's inputs and outputs are assessed to determine the net highest and best use and value;
- IRM focuses on resource recovery and extracting maximum value. It uses a net highest and best use and value model that includes environmental factors, consistent with the valuation principles that underlie the Vancouver Valuation Accord, to which the province is a signatory;
- IRM considers the overall net impact on the taxpayer. Common valuation and accounting analyses are of a single entity's perspective. IRM takes account of a broader set of impacts;
- IRM requires the integration of liquid and solid waste streams to maximise values for recovering energy in the form of biofuels, heat, minerals, water and reducing electricity demand;
- IRM is linked to water management through reuse of treated water for groundwater recharge and to offset potable water use for non-potable purposes such as irrigation, including potential commercial use, which contributes to maintaining or improving the health of the Province's watersheds;
- IRM is not a technology but a concept and process. It mimics ecological cycles of reuse and presents a resilient design that can better accommodate future challenges required for adaptation to climate change and population growth; and,
- In its full/optimal deployment, IRM can potentially result in zero waste.

The traditional approach to waste and water treatment and the IRM approach are compared in Table 1.

Table 1: How IRM Differs from Traditional Waste Management

	Traditional Waste Management	Integrated Resource Management
<i>Primary Objective</i>	To safely and economically dispose of waste.	To realise the greatest environmental, social, and economic values from waste. To achieve <i>zero waste</i> .
<i>Economics</i>	Focus is on cost.	Focus is first on revenues, then on the costs required to generate the revenues.
<i>Environment</i>	Designed to prevent pollution, but can unintentionally cause other forms of pollution, for example in the form of leachate and methane emissions from landfills.	Reduces pollution, for example by displacing fossil fuels with biofuels for transportation. Reduces net water demand, therefore allowing more water to remain in rivers to meet ecosystem needs.
<i>Energy</i>	Consumes energy, for example in the form of energy to run garbage collection and landfill operations.	Produces energy, as for example when organic solid waste is digested to produce methane for vehicle fuel.
<i>Infrastructure Design</i>	Form follows function: wastewater treatment plants and landfills are designed with a primary focus on safe disposal, and with existing infrastructure in mind.	Form follows function: wastewater treatment plants and resource recovery infrastructure are designed to serve the needs of customers for recovered resources such as including energy and water.
<i>Scope</i>	Deals with waste streams individually.	Accounts for synergies among all waste streams (<i>e.g.</i> solid waste, wastewater) and all community needs (<i>e.g.</i> water, energy, sustainable employment).
<i>Resource Recovery</i>	Resource recovery is possible, but not optimal. For example, landfill gas capture systems can only recover a fraction of the methane emissions from decomposing organic waste.	Resource recovery is maximised. For example, biogas digesters can recover the majority of energy available from decomposing organic waste as methane.
<i>Climate change</i>	Potentially increases GHG emissions from landfills and from increased energy needs	Contributes significantly to reduction in GHGs.
<i>Accountability</i>	Accounts for the financial costs of individual waste streams.	Accounts for the total economic benefit and cost of recovering waste streams as resources. Accounts for the total greenhouse gas impacts of all waste streams.
<i>Use of land</i>	Requires large amounts of land close to discharge locations such as oceans, <i>i.e.</i> usually expensive and visually intrusive. Largely requires water-based discharge.	Minimises or eliminates land use. ¹ Visually minimal (capable of being entirely subsurface, although ideally with heat plants at grade). Capable of discharge onto land or water.

¹ The City of Dallas is understood to be considering adding a system for separation and recovery to its existing traditional plant. The company analysing this represent this could reduce land use from 44 acres to 2 acres.

	Traditional Waste Management	Integrated Resource Management
<i>Scale</i>	Requires pipes and plant to be sized to meet future population increase and demand and mostly built at inception. Highly reliant on projection accuracy for size and location of population growth.	Adaptable to growth as and where it occurs. Just-in-time construction. Thus, low dependence on growth projection accuracy.
<i>Redundancy & fault tolerance</i>	Uses large plants, so greater redundancy is required to mitigate possible failure, increasing initial expense. Not very adaptable to technological redundancy.	Network of small plants improves fault tolerance. Load from a failed plant could be diverted to other plants. Can take advantage of technology improvement.
<i>Social Aspects</i>	Creates local jobs relating to waste management.	In addition to jobs created for waste management, creates sustainable local jobs relating to resource recovery.
<i>Procurement</i>	Either government-owned and procured, or private sector owned/procured. Requires taxpayer funding.	Either government-owned and procured, or private sector owned/procured. May not need taxpayer funding.
<i>Economic competitiveness</i>	Adds cost, does not contribute to economic competitiveness.	Projected to be revenue positive (<i>i.e.</i> profitable). Reduces tax burden, thus contributing to BC's economic competitiveness.

IRM Infrastructure

The main elements and processes of the IRM approach are shown in Figure 1. This depicts three waste streams—raw sewage, wet organic waste and dry organic waste. Variants of this approach can be applied in most communities in BC.

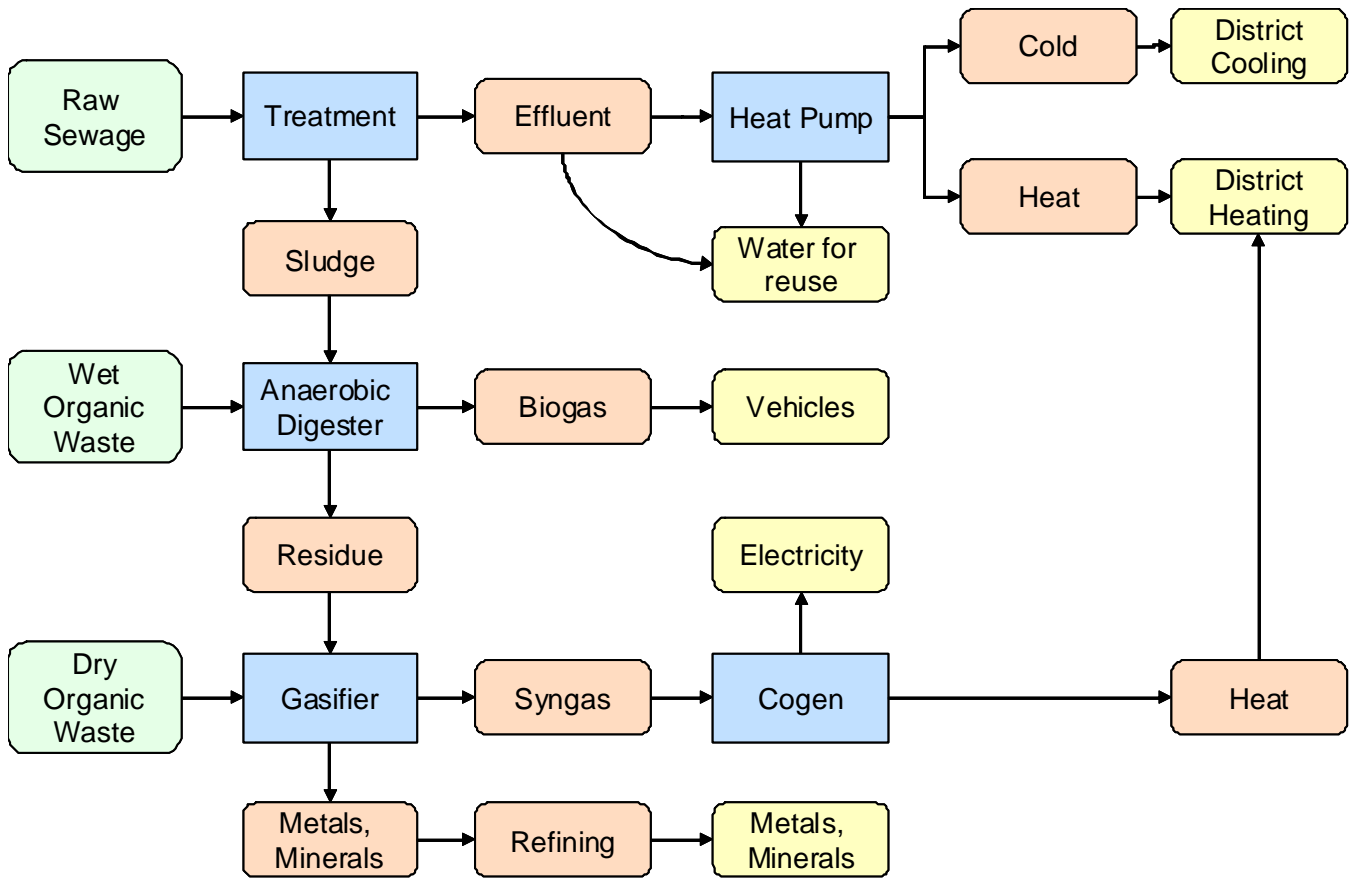

Figure 1: IRM Concept Diagram

Raw sewage primarily contains heat and water, and organic matter which has an energy value. Wet and dry organic waste can be processed to recover energy, heat and water.

Depending on the conversion technologies chosen, the outputs from this are heat, water, biofuel and electricity. The quantity of end waste material can vary depending on how IRM is implemented and can address toxic constituents, which are processed and contained as inert materials. This can be a "zero waste" model if properly implemented.

Summary of the Capital Region Example

The Study Team undertook a sensitivity analysis of the full deployment of the IRM model in the Capital Region based on three scenarios — chosen values, optimistic values (strong markets, manageable costs and good general financials) and pessimistic values (weaker markets, higher costs, poor financials). The results are summarised in Table 2, which shows projection estimates to 2065, to parallel the cash flow horizon chosen by CRD.

Table 2: Financial Summary, Capital Region IRM

	Chosen Values	Optimistic Values	Pessimistic Values
Annual Revenues	\$114,000,000	\$436,000,000	\$60,000,000
Annual Costs	-\$53,000,000	-\$50,000,000	-\$54,000,000
Net annual revenues	\$61,000,000	\$386,000,000	\$5,000,000
Projection to end (yr)	2065	2065	2065
Total NPV, IRM, stabilised	\$505,000,000	\$6,334,000,000	-\$244,000,000
Total Value (cost), stabilised, undiscounted	\$3,053,000,000	\$18,514,000,000	\$45,000,000
Capital Cost (Current Dollars)	-\$671,000,000	-\$600,000,000	-\$748,000,000
Capital cost (Inflated)	-\$870,000,000	-\$594,000,000	-\$976,000,000
Annual reduction in GHG emissions below 1990 in CRD (tonnes/yr)	378,000	404,400	367,500
Annual reduction in GHG emissions below 1990 in CRD (%)	23%	25%	23%
Annual electricity saved (\$)	\$6,000,000	\$12,000,000	\$6,000,000
Annual electricity saved and produced (GWhr/year)	116	129	124
Annual fossil fuel displaced - vehicle fuel (l/yr)	28,405,000	30,590,000	26,220,000

Note that the increased value of "Annual electricity saved and produced" under the Pessimistic scenario is caused by the assumption that annual water flows are higher under this scenario.

Table 16: Preliminary Scenario Analysis, Capital Region shows in detail how the inputs to the three scenarios differ. In general terms, to create the optimistic and pessimistic scenarios, the Study Team increased/decreased the following types of input to the IRM model:

- Revenues received for energy;
- Costs paid for infrastructure;
- Financial variables such as inflation rates, finance rates and construction contingencies;
- Physical variables such as energy conversion efficiencies and population growth.

The IRM model's business case for the Capital Region have not changed in the final draft report following the analysis of peer review comments. This should not imply that the Study Team is not aware of suggestions for further improvement offered by the reviewers, but feel that these may best be addressed in subsequent stages of analysis. In addition, the proposal for a carbon tax on fossil based fuels in the Provincial budget has not been factored into the metrics though it would increase the values associated with carbon-free energy and boost the market for these fuels (*i.e.*, initial assessment is that it will improve IRM's financial results). We expect that IRM would especially improve performance relative to more traditional approaches, which would be more highly taxed.

The assumptions behind the model are too extensive to be presented in this Summary. Please see *Appendix H: Business Case*, for more detail. The combined key aspects are summarised as follows:

- With the progressive application of the provincial carbon tax over the next five years the costs for full application of IRM to the CRD could potentially be recovered by resource values in the

chosen and optimistic scenarios. There could be a net cost to taxpayers under the pessimistic scenario if the capital, operating and maintenance costs of the distributed waste treatment plants are higher than presented in this report, as suggested by some of the peer reviewers. The Study Team is confident that with sound management, IRM could be implemented with very significant cost reductions to the taxpayer compared with the approach proposed in June 2007 by the CRD;

- IRM has the potential to reduce GHGs significantly.² Reductions will be more limited if resource recovery is added onto existing systems or traditional approaches to waste management. Where the full deployment of the IRM approach is possible, it will assist local governments in meeting their commitments in the BC Climate Action Charter;
- The potential combined electrical energy savings and new energy generation total between 116 and 129 GW hours per year in the CRD example. Thus IRM can contribute significantly to the provincial Energy Plan targets. The Study Team has met with BC Hydro which is interested in including IRM projects in its energy conservation plans. IRM has the ability to support energy independence on Vancouver Island;
- Ecological benefits are undervalued in the model because GHGs, water, carbon etc. are not fully reflected in market prices. In the words of one of the peer reviewers³:

‘ the value of carbon in compliance markets...is currently above \$30 per tonne and likely to increase significantly as the risks of climate change become more severe in the coming years’.

More work will be needed to refine the model, but following review by the Technical Advisory Committee and the peer reviews, there is general consensus that IRM has the potential to be implemented in CRD and elsewhere in the province and should proceed for more detailed and refined planning and assessment as part of the steps to implementation. This may sensibly be achieved through application to a range of demonstration projects. Should these steps prove satisfactory, the model could be more widely implemented.

Implementation Strategy

Traditional infrastructure is being designed and built daily which reduces the potential to meet the Province’s carbon, GHG and other targets. If built, these systems will lock the communities building them into traditional waste management for decades to come.

The full and optimal deployment of the IRM approach could take many years to implement across the Province as it would require significant changes. However near-term modifications may be possible

² The Greenhouse Gas Reduction Targets Act, 2007.

³ Dr. Charles McNeill, United Nations Development Program.

provided IRM is adapted to local circumstances. This is unlikely to be optimal but would permit incremental steps to be commenced.

The Study Team has proposed a road map for implementation that would enable the provincial and local governments to make the appropriate changes in a series of incremental steps. To realise the full potential for resource recovery and contribution to the Province’s energy and climate change legislated targets, all steps in the road map must eventually be implemented.

The Team divided IRM into categories that provide potentially the highest values from resource recovery (HV) with the lowest costs and have relatively lower risks (LR) or barriers to implementation, to components that produce lower values in resource recovery (LV) at higher costs and currently involve higher risks (HR) that will require more research and evaluation before they can be implemented. This is illustrated in Table 3.

Table 3: IRM Implementation Values and Risks

IRM Implementation: Risks and Values

	Values						Risks					Overall Assessment	
	Energy Recovery	GHG Reduction	Water Conservation/Reuse	Environmental Benefits	Financial Benefits	Social Benefits	Technology	Timing	Social Risk	Implementation	Overall Risk		
<p>IRM Activity The options below are not intended to show a sequence in time, but rather options for municipalities. A given municipality for example, may benefit from working on several of these options at the same time. The list is not complete and review is recommended to identify additional value and risks prior to implementation. Community & political acceptance has been assumed.</p>													
Solid waste streams	Communities which have existing wastewater treatment plants and anaerobic digesters could increase biogas production from this existing equipment, by diverting as much wet organic waste into existing WWT plants as possible.	MV	MV	N/A	HV	HV	HV	LR	LR	MR	LR	LR	H
	Communities which have no anaerobic digesters could build new digesters to process wet organic waste into biogas, for upgrading to vehicle fuel or for cogeneration.	HV	HV	N/A	HV	HV	HV	LR	MR	MR	LR	LR	H
	Any community could build new gasifiers to process dry organic waste into syngas for cogeneration.	HV	MV	N/A	HV	MV	MV	MR	MR	HR	LR	MR	M
Liquid waste streams	Any community can apply the IRM Model to new developments.	HV	HV	HV	HV	HV	HV	LR	LR	LR	LR	LR	H
	Communities which have little or no wastewater treatment can apply the IRM Model.	HV	HV	HV	HV	HV	HV	LR	MR	HR	MR	MR	H
	Communities with infrastructure which must be upgraded or replaced can apply the IRM Model.	MV	HV	LV	HV	HV	MV	LR	MR	HR	LR	MR	M
	Apply the IRM Model to communities which are short of water.	MV	HV	HV	HV	MV	HV	LR	LR	MR	MR	MR	H
	Communities with recently built and fully deployed infrastructure, with a stable population.	MV	LV	LV	LV	LV	LV	LR	MR	HR	MR	MR	L

HV = Higher value
MV = Medium value
LV = Lower value

LR = Lower risk
MR = Medium risk
HR = Higher risk

The implementation road map in Table 3, while not providing a complete and exhaustive guide to considering IRM, would involve the following questions:

- Does the community have an existing wastewater treatment plant with an anaerobic digester—if yes, then improve the efficiency and capacity of the digester and add wet organic wastes to the feed stock of the digester—for example Annacis Island in Metro Vancouver;
- Does the community have a wastewater treatment plant but no anaerobic digester—consider collecting wet organic waste or bio-energy resources from farms, forests or forest industry and combine with new organic sludge in a centralised digester;
- Does the community collect dry organic waste—consider collecting dry organic waste from the community building a waste to energy facility to produce electricity and heat;
- Is there a major new development proposed for a community—apply the IRM model to the development and seek access to sewage and organic solid waste from neighbouring communities to add value to the investment;
- Is the level of sewage treatment either primary or not in place—Apply the IRM model to retrofitting suitable neighbourhoods and commercial areas with resource recovery and district heating and cooling and combine treatment with wet organic wastes to maximize bio energy values—for example upgrading the Lion’s Bay treatment plan in North Vancouver;
- Does the community face water shortages in groundwater or streams—consider demonstration projects for distributed water treatment systems to recharge streams or groundwater sources;
- Are there parts of the wastewater distribution system that require upgrading—if so, consider distributed treatment plants to extract energy for local markets—*e.g.* James Bay in Victoria (*Figure 13. Water and Energy Recovery Cell (WERC) concept diagram for James Bay and Legislature Precinct* on page 37);
- Has the community recently completed its wastewater upgrading— consider collecting wet organic wastes and combine with organic sludge.

Generally the IRM model will be more attractive to communities that require upgrades to infrastructure in the near future and have rapidly developing areas and will be less attractive to communities that have a fully developed infrastructure and little new development proposals.

Conclusions

The Study Team has reached the following conclusions:

Provincial Level

- IRM has the potential to be a viable solution to water, solid and liquid waste management that should be less expensive, result in fewer environmental impacts, and provide greater flexibility than traditional approaches to waste management;

- Further work is needed to evaluate IRM as has been suggested in the peer reviews. In particular the proposal for distributed wastewater treatment plants requires further analysis through deployment of a range of demonstration projects to improve estimates of capital and O&M costs;
- All the technologies presented in this study are well established, currently operational and in use in various jurisdictions, however we are not aware that they have previously been fully integrated in a single location, in a region-wide application;
- IRM can contribute significantly to the Province achieving its goal of operating a carbon neutral government and public institutions by 2010 and 33% reduction by 2020. Should the Province decide to implement it as a program, it could theoretically achieve nearly two thirds of the Province's goals, achievable in the timescale set by the Province and potentially, with little or no cost to the taxpayer. Few similar initiatives are currently known to the Study Team capable of achieving this level of benefit without appreciable taxpayer cost or societal change;
- The level of GHG emission reductions in any community will depend on the applicability of IRM to its level of infrastructure development. The most significant reduction can be achieved by combining organic sludge from existing water treatment plants with wet organic solid wastes and other sources of bio-energy as outlined in the Province's bio-energy strategy;
- IRM has the potential to support the achievement of the targets set in the BC Energy Plan through a combination of reduction in energy use and the creation of new energy sources. This represents the potential to achieve an appreciable portion of the energy plan from a single change under government control;
- IRM can contribute to the Province's water strategy as proposed in the 2008 Throne Speech by encouraging water conservation at source and reuse for non potable applications, thereby reducing the flows required for treatment and by recharging streams in the summer and fall to sustain environmental flows;
- Recharging wetlands and watercourses can provide localised carbon sequestration for use as carbon credits and increasing ecological resiliency for wetland ecosystems to adapt to climate change. This has not been captured financially in the current model;
- IRM exceeds typical current environmental standards for waste discharges from most plants by providing tertiary levels of treatment;
- IRM is fully consistent with the government's LiveSmart BC initiative outlined in the 2008 Throne Speech. This initiative supports 'carbon smart communities, that are energy smart, water smart, health smart and resources smart.' These are all the same principles as IRM and the foundation to this proposal;
- IRM is a new approach to managing resources and will face resistance from community groups and officials who are comfortable with the status quo. Education and information will be required to address this;
- Some components of IRM can be implemented more quickly than others depending on the availability of markets for resource recovery values and the status of water, sewage and solid waste services. The Study Team has prepared a road map for implementation that should be

considered by each local government and especially those that have signed the Community Climate Charter in making decisions on implementation of IRM;

- Placing a value on waste resources will significantly change the dynamic for managing these wastes compared to the more traditional model where waste is considered only a cost driver. The review of liquid and solid waste plans recommended below will have to consider how these assets are distributed between regional and local governments;
- It will benefit municipal and regional government to more strategically address their resource management planning, or the optimal benefits available from IRM may not be achieved. This will affect all levels of government planning.

Recommendations

1. The IRM model should be further refined through implementation of carefully selected pilot projects in BC communities in accordance with needs and opportunities to support the Province's climate change action plan. Provided ongoing monitoring and assessment of these pilots provide satisfactory results, a more broadly-based implementation approach should be undertaken. The IRM study was initially intended to be conceptual in its level and scope of analysis. However, the additional analysis conducted to-date and the responses of the peer reviewers provide a sufficient level of assurance to recommend early implementation of pilot projects.

2. The IRM model should be refined without delay, as without its early implementation, traditional projects will continue. Traditional plant commitments will result in increased GHGs, increased power consumption, reduced revenue potential, failure to achieve water and energy conservation and reduce the ability to optimise generation of power, heat, fertiliser and biofuels.

3. At least one sizeable community in the Province should apply the full array of IRM as a demonstration project to use the iterative business model to seek out maximum values, to assess all relevant costs, to engage the citizens in a real example of whole city change and to determine the potential for GHG reductions. Such a demonstration project would place the province in the forefront of the Green City agenda and provide the potential to twin the project with a similar-sized community in one of the US states and Canadian provinces under the Western Climate Initiative.

4. IRM requires an integrated team approach to implementation. The Province should establish a project office to implement IRM whose members are innovative thinkers from across government and the private sector and form a complete and balanced team with the expertise to address both the technical and governance aspects of IRM. This team should:

- Continue with more detailed modelling to refine the cost and revenue potential for IRM in the Capital Region, and elsewhere in the province, on a site-specific and integrated network basis;
- Assess in more detail the risk associated with the implementation of the IRM model and ways to reduce these risks through market incentives and associated government policies;

- Identify how and where the IRM model might be applied to achieve the target of public institutions, including post secondary institutions, becoming carbon neutral by 2010 and to support GHG reduction by 33% by 2020;
- Work with UBCM and the Ministry of Community Services to encourage local governments to apply the IRM approach to all new infrastructure expenditures. Specific circumstances for individual projects will determine the extent to which IRM can be deployed;
- The project office should identify at least six to eight municipalities and regional districts from various regions of the province that are in a position to apply components of IRM to liquid, solid waste and water supply system expansions and upgrades. Bring a prioritised order to Cabinet, with recommendations, within six months;
- Immediately develop a strategy to collect organic solid wastes in municipalities to take advantage of integrating solid and liquid waste management plans. Every day there is delay, a source of carbon neutral energy is being lost and more methane is emitted from landfills;
- Develop and require new business case metrics for evaluating projects. More on this is noted separately, below;
- The Province should require all liquid, solid waste and water supply infrastructure upgrades and expansions submitted for provincial funding to include IRM or at least meet new metrics for evaluating applications and help achieve the GHG targets;
- The review of waste management plans should consider the implications of waste streams having a value and how this value is allocated between municipal and regional governments and with sources of waste from the private sector;
- IRM is designed to be fully compliant with all current applicable environmental and health standards in BC; however, the Province should review all relevant legislation and regulations that apply to the implementation of the IRM model and remove unnecessary barriers. This review should involve an integrated evaluation of water licensing, waste management, health standards and municipal infrastructure financing programs. Bring this review back to Cabinet within twelve months;
- Integrate the following regional plans and planning processes as soon as possible:
 - Liquid Waste Management Plans
 - Solid Waste Management Plans
 - Regional Growth Strategies
 - Official Community Plans
 - Community Energy Plans
 - Water Servicing Plans

- Integrate government plans for a green building code with the IRM model, to ensure they are mutually compatible and provide clearer and immediate direction to developers to apply the IRM model to new large-scale developments across the province;
- Some municipalities require unnecessary duplication of infrastructure, or levy charges for avoiding traditional infrastructure. This acts as a disincentive to environmental responsibility and IRM. Ensure that the IRM model is not harmed by current development cost charges, levies, taxes and debt financing policies in municipalities. Ensure that municipal, regional and provincial policies act as an incentive to encourage IRM applications, and not as a barrier;
- Use the project office to monitor and ensure adaptive learning and development of IRM during implementation to initial projects, such that the model can be continuously refined as subsequent projects are brought on-line;
- Identify how the model, through a more detailed assessment of its application to the recommended large-scale demonstration projects in the province, might be transported to the member jurisdictions of the Western Climate Initiative and internationally;
- Implement pilot projects as a risk-appropriate method of implementing IRM, while evaluating and refining the IRM model. Initially emphasise retrofit pilots since these provide initial backup to existing infrastructure, if it proves necessary;
- Consolidate information on all financing programs available for implementing components of IRM in federal, provincial and local levels of government in a single window to expedite access to these programs by developers.

5. The following recommendations apply to improving business case analyses to encourage the full application of IRM

- Change the metrics for evaluating business cases to put resource use, reuse, recovery and net revenues first, so the net impact to the taxpayer is explicit. Include climate change metrics in the business case so sustainability is fully integral to business case models. Flow this through to be part of the transparent (*i.e.* published) evaluation criteria for procuring infrastructure;
- GHG emissions reduction should be used as key performance criteria for all municipal infrastructure, including infrastructure which relates to waste management. Include GHG levels, carbon credits and carbon taxes as evaluation and pricing criteria in both modelling and procurement. This is consistent with the Premier's commitment to the Vancouver Valuation Accord;
- Life cycle costing as currently implemented is mainly focussed on cost savings. It must be replaced by full life cycle valuation, including environmental factors. The value and cost of all components of a model, including any residual value or cost, must be included in models, analyses and evaluation and procurement criteria;

- The economic importance of the IRM approach is also significant. There is an immense opportunity for BC business to develop and apply the technologies outlined in this report. This will require a partnership between the regulatory responsibilities of government and the entrepreneurial skills of the private sector.

Application of IRM to the Capital Region

In the past two months the Capital Regional District has received direction that indicates that the IRM model should be applied to its solid and liquid waste plans following the appropriate engineering and market assessments set out in this report and in the peer reviews. The direction from the Minister of the Environment⁴ states that the CRD should examine:

- Minimising total project costs to taxpayers by maximising beneficial reuse of resources
- Optimising resource recovery through a more distributed infrastructure model
- Aggressively pursuing reductions in GHG emissions
- Optimising smart growth results by encouraging green development such as Dockside Green
- Integrating liquid and solid waste resource recovery opportunities

In addition, the CRD has recently signed the Climate Action Charter and Community Energy Plan committing it to achieve a 33% reduction in GHGs by 2020.

Full deployment of the IRM model in the Capital Region could potentially result in a reduction of over 23% in GHG emissions assuming that markets can be found for all generated non-fossil-based energy.

The Capital Region could become a leader in implementing IRM as it is committed to resource recovery and IRM could enable it to achieve a tertiary level of wastewater treatment in the timeframe required for secondary treatment by senior government.

The Study Team recommends that the following actions be implemented:

- Integration of liquid and solid waste management plans to include collection of all organic wastes in the Region;
- Adopt resource recovery as a driving component of regional facilities to recover gas, heat and energy from the co-management of solid and liquid waste streams;
- As a starting point, model, design and construct at least three, and ideally six, localised water treatment and heat recovery facilities beginning in 2008 where there is a readily available market for carbon neutral energy to meet the provincial legislative targets;

⁴ Letter from Barry Penner , Minister of Environment, to the CRD Board, December 14, 2007.

- One of these pilots should be in James Bay where the sewage infrastructure requires upgrading. It might be possible to establish a wastewater treatment demonstration project in the neighbourhood and use the heat pumps to heat local government offices, commercial establishments and the Legislature (Figure 13 on page 37). Highly treated water could be used to replace potable water for irrigating the Legislature grounds and Beacon Hill Park. Other locations for pilots include the University of Victoria, Royal Roads University, and the Department of Defence lands in Esquimalt;
- Access to large amounts of organic wastes from agricultural sources in Central Saanich plus access to the Saanich Peninsula Hospital provides a potential demonstration project to implement the province's bio-energy strategy;
- Rapid development in the West Shore communities provides opportunities for IRM to be applied to new developments, for water reuse from localised treatment plants for golf courses and stream recharge;
- Encourage interested developers in the Region to implement IRM in their proposed developments and work with municipalities to accelerate the adoption of IRM;
- Immediately start an analysis of the extent and nature of deferred maintenance in the Capital Region, including both CRD infrastructure and municipal wastewater collection systems (*e.g.* stormwater overflows, lift stations, piping etc.). Review all analyses of all traditional approaches to these maintenance requirements in light of the IRM model and business case; and
- Create an integrated model and governance structure in the Capital Region and member municipalities to manage both municipal and regional solid, liquid waste and water systems, including operating and maintenance costs.

Resources from Waste

Integrated Resource Management Phase I Study Report



Introduction

Purpose and Scope

The purpose of this Phase 1 study is to determine whether there is a business case for a more sustainable and integrated approach to wastewater management and resource recovery for communities in British Columbia. Specifically the objectives of the study were to:

1. Evaluate the potential to advance provincial Climate Change and Green City Project objectives (including energy and water conservation), and to optimise taxpayer values by integrating wastewater management with the management of energy, stormwater, drinking water, rainwater and solid waste, including resource recovery;
2. Evaluate whether this alternative approach is both technically feasible and economically viable (including a strong sense of the potential business case) over the long term (including long-term operating impacts, and flexibility to deal with future changes in the population and environment) using the Capital Regional District as a case study; and, providing the evaluation is favourable,
3. Propose an action plan for implementation.

The project scope is further detailed in *Appendix A: Project Scope*.

In reference to Objective 1, the principal components of the Province's climate change agenda that are relevant to the IRM study are⁵:

- Reduce greenhouse gases (GHGs) by 33% by 2020, with legally binding interim targets for 2012 and 2016;
- All electricity produced in the province will be required to have zero greenhouse gas emissions by 2016;
- Government ministries, Crown corporations and post-secondary institutions to be carbon neutral by 2010;

⁵ Province of British Columbia. 2007. Speech from the Throne. The Honourable Iona Campagnolo, Lieutenant-Governor at the Opening of the Third Session, Thirty-Eighth Parliament of the Province of British Columbia, February 13, 2007.

- GHG targets to be legally incorporated into Official Community Plans (OCPs) and Regional Growth Strategies;
- Regulate landfills to use methane beneficially and reduce trucking to landfills;
- Encourage district energy systems;
- Encourage organic waste recovery;
- 50% of new energy requirement to be obtained from energy conservation;
- New energy sources to be carbon neutral; and
- Assist in implementing the Provincial bioenergy strategy.

The IRM study will require a more detailed assessment of treatment cost and resource recovery opportunities (Phase 2) than can be provided in this initial Phase 1 analysis. It is thus important to understand that this current study has limitations and falls short of the detailed analysis needed for full analysis and application of an IRM approach. Proposed next steps are described in the *Conclusions* on page 56.

Report Structure

This report is presented in eight major sections:

- **Executive Summary and Key Recommendations;**
- **Introduction** to the project and scope;
- **The Integrated Resource Management Approach:** An outline of the IRM approach, and how this might be applied in British Columbia;
- **Resource Recovery Technologies and Opportunities:** A look at the technologies that might be used for wastewater treatment, and a description of the resources that can be obtained from waste;
- **The Capital Region Example:** A description of how the IRM approach might be applied in the Capital Region;
- **The Business Case for IRM:** The financial, social and environmental analyses of the IRM approach and an examination of the potential benefits and challenges that might result from IRM implementation;
- **Reviews and Comments:** Comments from expert advisors on the IRM approach; and,
- **Conclusions and Recommendations.**

Several technical appendices are provided with more detail on components of the IRM approach.

Authors and Contributors

An integrated interdisciplinary team of engineers, valuation experts, ecologists and public policy experts with advice and technical support from other specialists including those in the fields of sustainable development and regional and provincial government authored the report. A list of authors and contributors is provided in *Appendix B: Authors, Contributors and Reviewers*.

We gratefully acknowledge the contributions from the project's Technical Advisory Committee (TAC), including members of the provincial government, Capital Regional District and consultants, for their valuable input concerning financial and non-financial aspects of the study. We are also grateful to the many external experts in British Columbia, Canada, the United States, Australia, Germany, Sweden and Great Britain for their contributions. Comments from reviewers on an earlier draft of this report are provided in the *Appendix I: Reviews and Comments* section. Finally we appreciated the responses by the four Peer Reviewers selected by the Steering Committee. Many of these comments should be considered by the government during implementation of the IRM concept.

Traditional Waste Management

In most municipalities, water is only used once in households, institutions and commercial facilities and then discharged as sewage. Sewage is treated as a waste – a problem to be disposed of. This sewage is piped to centralised waste treatment facilities where it is treated and discharged to the environment in accordance with environmental regulations.

There is usually little resource recovery from this treatment, although recently examples are becoming more common. In the case of solid waste, the blue box program instituted in the 1990s recovers a range of recyclable products, and garden waste may be composted, but most of the wet organic waste is disposed of in landfills leading to the release of methane gas. The CRD is capturing a portion of this gas as an energy source, but this approach is not commonly used at landfills across the province.

In BC, wastewater is part of an array of services traditionally supplied and funded by local government, with regulations established by the senior levels of government. Senior governments also typically contribute capital funding.

Generally, drinking water, wastewater, stormwater and solid waste infrastructure are managed and operated separately. Budgets for one type of infrastructure are independent of other types of infrastructure, yet they have interrelated impacts.

- Water becomes wastewater between the tap and the drain; however, prior to the water becoming waste, there has been considerable investment in water capture, storage, purification, delivery and heating (*i.e.* piping and pumping).
- Single use of water rather than reuse or recycling results in increased demand for potable water as population grows, increasing the cost of the potable water department's budget. Conversely, if water could be reused or recycled, this would reduce demand on the water source (*e.g.* reservoir, creek, lake or well) and thus reduce potential costs of water capture, treatment and delivery.
- Rainwater capture and reuse for non-potable purposes would further offset potable water demand and reduce the burden on stormwater infrastructure while improving ecological function of urban streams.
- Water recycling and reuse in turn reduces energy consumed for pumping and treating water. Finally it affects the wastewater budget, as more pipes and treatment are needed than if consumption were handled differently, with an emphasis on reuse.

The net effect of the traditional approach to treatment is a system that usually increases costs to taxpayers, relative to what might be achieved through reuse and recycling. Traditional solid waste disposal practices also increase greenhouse gas emissions through methane release and increases in energy requirements at multiple levels.

The emphasis for traditional waste treatment is placed on minimising costs while meeting applicable environmental regulations. The emphasis on IRM is to maximise resources, revenues and broader benefits while meeting environmental regulations.

In the traditional approach, waste and water streams are generally managed in three separate streams:

- **Solid waste.** Wet organic or kitchen wastes; dry organic or garden wastes and wood wastes are handled separately. Some of this material is composted; little of it is converted to energy. The residual waste is generally land-filled.
- **Liquid waste** or sewage is piped to centralised waste treatment plants and is discharged in accordance with applicable provincial and federal regulations. Some of the sludge at treatment plants is converted into energy, but the main emphasis is to minimise costs required to meet environmental standards.
- **Storm water** is generally discharged to storm sewer systems and to treatment plants or directly to the environment. There are some examples of discharge to ground through detention ponds or infiltration basins.

IRM integrates these approaches to optimise resource recovery and value.

The Integrated Resource Management Approach

Resource management and resource recovery are not new concepts. Examples of the reuse and recovery of water, energy and solids from liquid and solid wastes are international (see Table 4 on page 8).

Resource recovery in traditional waste management is normally retrofitted after the fact, rather than in advance of designing and building infrastructure. As a result, resource recovery with traditional facilities is possible but not optimal. For example:

- Biogas digesters are more efficient at producing methane for use as a biofuel than landfills and they avoid other forms of pollution related to landfills (leachate, groundwater contamination, odour, unproductive consumption of natural land, greenhouse gas (GHGs));
- Gasification and similar plants are not usually located close to consumers, with consequent loss of heat energy (*e.g.* locating a plant at Hartland landfill would not capture excess heat for district heating);
- Location of treatment and resource extraction/recovery plants is usually distant from the sources with consequent increases in infrastructure cost for resource capture and transportation. This increases the volume, increases leakage risk and odours, piping cost, and significantly increases both downstream plant costs (which have to be increased in size when this is avoidable), and raises original capital costs and ongoing operations and maintenance costs; and,
- Centralised wastewater treatment plants are commonly located near the bodies of water they discharge into, rather than near the potential customers for reclaimed water and energy (with consequent loss of ability for localised groundwater recharging, carbon sequestration and increase in GHGs and costs through transportation and efficiency reduction).



Figure 2: Thorsø Biogas Plant, Denmark⁶

With IRM, wastewater and solid wastes are viewed as resources. IRM considers how best to use the resource to maximum benefit. It integrates the management of solid and liquid wastes, the use of recovered resources, and value. This can best be illustrated by reference to the main inputs to the system, which is diagrammed in Figure 3: IRM Concept Diagram on page 9.

⁶ Photo courtesy of Danish Institute of Agricultural and Fisheries Economics.

Table 4: Resource Recovery Examples

Resource	Recovery Examples
Water	<p>Highly-treated water from central wastewater treatment plants can be piped to end users.</p> <ul style="list-style-type: none"> In San Diego, a system of 'purple pipes' carries reclaimed water from the North City Water Reclamation Plant and South Bay Water Reclamation Plant to end users. In Edmonton, the Gold Bar treatment plant provides reclaimed water to the neighbouring Petro Canada oil refinery.
Methane	<p>Landfill gas capture systems can capture a portion of the methane produced by landfills to produce electricity. Landfills are porous however, and the methane which escapes collection is a potent greenhouse gas with a Global Warming Potential 21 times stronger than carbon dioxide.</p>
Biogas	<p>Larger wastewater treatment plants digest primary and secondary sludge in anaerobic digesters to produce biogas, which is burned in cogeneration units to produce heat and electricity for the plant.</p> <ul style="list-style-type: none"> The Metro Vancouver's Annacis Island wastewater treatment plant meets approximately 60% of its electricity needs in this way. Plants can become more self-sufficient when their digestion processes are updated: thermophilic digestion (55°C) produces higher methane yields than the more common mesophilic digestion (35°C) process.⁷ Metro Vancouver's Lulu Island wastewater treatment plant will implement MicroSludge pre-treatment technology to increase the yield of methane from sludge, enabling the plant to meet 70% of its electrical energy needs.⁸
Nutrients	<p>Nutrients can be recovered in the form of composted biosolids, or by chemical means such as the process which will recover fertiliser in Edmonton's Gold Bar treatment plant.</p>
Heat and cooling	<p>Heat energy can be extracted from treated effluent from centralised wastewater treatment plants, although the challenge is to distribute the heat recovered to decentralised users of the energy. European cities solve this problem by conveying the energy through existing district heating networks.</p> <ul style="list-style-type: none"> Treated sewage from Stockholm's Henriksdahls treatment plant is piped to the local energy company (Fortum) where heat pumps extract enough energy from the treated sewage to heat 20% of Stockholm's homes, or 80,000 homes in total.⁹ Revenues from this heat along with sales of biogas help Stockholm Vatten to offset the cost of treatment to citizens¹⁰; tertiary sewage treatment in Stockholm costs approximately \$78 per home per year¹¹, in contrast to the Canadian average of \$120 per home per year¹² for secondary sewage treatment without resource recovery. In Stockholm, the energy company is paid twice for the energy extracted through heat pumps: once for the heat energy, and again for the "cold energy." A number of district energy systems exist in Canada, including biomass-powered heating systems in:¹³ <ul style="list-style-type: none"> Trigen, PEI (33 MW) – energy source includes municipal solid waste Ajax, Ontario (35 MW)

⁷ Záborská et al. 2002. The contribution of thermophilic anaerobic digestion to the stable operation of wastewater sludge treatment, *Water Science and Technology*. Vol. 46, No 4–5. pp 447–453.

⁸ Metro Vancouver Waste Management Committee Minutes, September 12, 2007.

⁹ Per Dr. Marta Tendaj, Business Development Manager, Stockholm Vatten on October 9, 2006

¹⁰ Stockholm uses a centralized wastewater treatment approach. This limits the extent of resource recovery options. The proposed model for the Capital Region offers more extensive recovery and revenue opportunities, hence the net revenue forecast in the IRM model is higher.

¹¹ Per Dr. Marta Tendaj, Business Development Manager, Stockholm Vatten, on October 9, 2006

¹² Approximate cost of treatment to households in Sidney and North Saanich through the CRD's secondary Central Saanich Wastewater Treatment facility

¹³ Arkay, K. and Blais, C., 1999. The District Energy Option in Canada. Community Energy Technologies (CET), CANMET, Natural Resources Canada

Resource	Recovery Examples
	<ul style="list-style-type: none"> • Grassy Narrows, Ontario (0.8 MW) • Ouje-Bougoumou, Quebec (3MW) • Lonsdale Energy Corporation, North Vancouver (6MW) (see Figure 11) <ul style="list-style-type: none"> • Sewage-source heat pumps are gaining acceptance in Canada: heat pumps already recovery energy from the Kelowna wastewater treatment plant to heat Okanagan College, and sewage heat pumps will heat the Olympic Athletes' Village in Whistler, for example.¹⁴

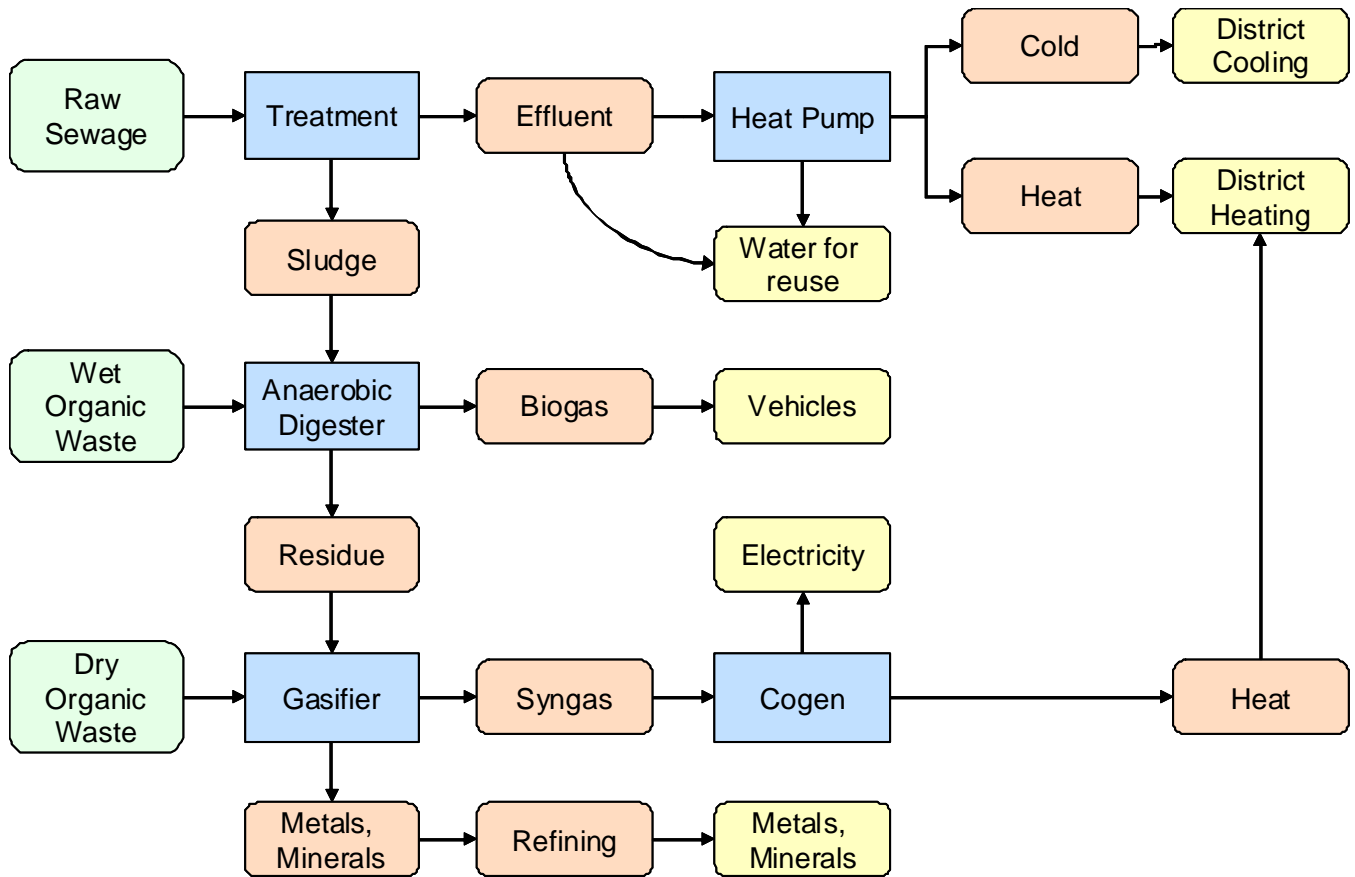

Figure 3: IRM Concept Diagram

¹⁴ Municipality of Whistler

Vision and Principles

The Study Team applied the following principles in developing an Integrated Resource Management model.

Recognise every "waste" as a resource	Waste can be considered 'a resource in the wrong place'. In the IRM model, every waste stream is considered as a potential resource. The value of that resource in the market is then estimated, together with the costs required to "upcycle" the waste for the market (see glossary).
Highest and best use and value	<p>The Study Team searched for the highest and best value from the use of resources, net of costs to obtain it. For example, organic waste may sometimes be more valuable as compost and in other cases as biofuels depending on markets. Biogas may be more valuable to run buses, or to produce heat and electricity. Reclaimed water may be used for irrigation or to recharge creeks and wetlands.</p> <p>The Study Team first developed a model and principles to evaluate the highest and best use and value, which included valuing ecological services. The economic value of each option was examined, and the team then listed the environmental and social benefits. These environmental and social values have been noted in the sections following.</p>
Revenues first, costs second	Traditional infrastructure planning scopes the requirements, then moves to engineering options and design, and costs the analysis. Revenues are then layered on top. This process places primary emphasis on cost, with revenues second. Placing net revenues as the first priority and mirroring private sector business practices by assessing the net most viable method for waste management, fundamentally alters the business case approach. It alters the solutions chosen and the process to achieve it.
Proper reflection of long-term cost and value	Standard financial approaches include risk and discounting methods that can disproportionately reduce long-term income or expense. Both major infrastructure and ecological services are especially affected by these approaches. The Study Team thus used both traditional financial approaches and undiscounted methods adapted from the development and leasing sectors, to illustrate whether balance in revenues and investments were being properly reflected.
Best long-term option, even if this requires new infrastructure	Investments in past infrastructure should not constrain exploring the benefits of resource recovery alternatives. If a resource recovery model does not use the existing sewer infrastructure because reclaimed water is diverted to a better beneficial use, then the sunk cost of the existing infrastructure should not discourage consideration of the benefits and value of resource recovery.

System boundaries, sub-optimisation, and synergies	The Study Team included the entire community within the system boundary, factoring in sewage, organic solid waste, and community needs for heating, cooling, transportation fuel, and water.
Use an integrated approach: Ecology, Economics, Engineering	The Study Team conducted brainstorming sessions in which the ideas of ecologists, economists, engineers and governance were treated equally. The focus for testing potential models was the business case, which contained both financial and non-financial aspects, into which social, economic and environmental considerations were assessed. This triple bottom-line approach substantially improved the combined benefits to the single taxpayer.

IRM has the following main attributes:

- **Smaller localised facilities:** Localised wastewater treatment facilities would range in size, but the smallest in the IRM model would require approximately 300 m² in total footprint, and be capable of being built on two or three levels. These facilities could be located underground in existing rights-of-way (roads, pathways or replacing existing pump stations). The plant equipment would be commercial off-the-shelf, which increases competition and reduces cost while improving delivery and replacement options, improving redundancy and ability to upgrade as technology improves. The optimum size and number of distributed plants would need to be refined in each implementation of IRM, *i.e.* detailed assessment will define the plant locations, sizes and capacities.
- **Reuse of organic waste:** Garden and kitchen waste would also be captured at the localised collection plants or at a central location. Municipal organic waste would also ideally be captured, from parks and roadside maintenance. Existing recycling or garbage collection could be adapted to undertake this, minimising cost impact as these services already exist.
- **Water treated and reused:** At the wastewater treatment plants, water would be cleaned and discharged/reused locally to minimise pumping costs. It could be used to recharge creeks and groundwater, for irrigation, or for commercial/industrial consumption, thus offsetting demand for potable water and enabling restoration of streams degraded by diminished summer flows. Localised separation and purification significantly reduces the volumes that must be redistributed for further resource recovery, reducing pumping and infrastructure costs. Multiple small discharges of wastewater treated to a tertiary standard would substantially reduce or eliminate the ecological impacts associated with wastewater discharge from a centralised location. *Note* that treatment plants proposed by CRD's recent study for the Core Area of the Capital Region will be designed to achieve secondary treatment at best: the treatment plants in the IRM model are designed to discharge tertiary, disinfected water.
- **Minor modifications to existing infrastructure:** Primary and secondary sludge which is separated by the distributed treatment plants in the IRM model can either be dewatered for transportation to a biogas digester by truck, or pumped to the digester as a slurry through pipes. Other pipes would be required to connect distributed plants to each other, so that flows from an overloaded or malfunctioning plant could be referred to other plants. These new pipes could use existing sewage pipes as sleeves, so new pipes can be laid quickly at low cost and as a single

continuous pipe with no joints, minimising leaks, improving fault-tolerance, and minimising or eliminating odour. Minimal excavation is anticipated, except as part of normal replacement of old existing sewers. These "pipes within a pipe" allow for a network of wastewater treatment plants to be created. Where new pipes need to be laid, the smaller dimensions of IRM pipes mean the cost is significantly reduced. This approach is expected to be advantageous in systems where there is high inflow and influent and/or extensive deferred maintenance. The draft specification exceeds the required standards for handling the largest projected inundation flow rates. See *Appendix D: Waste Treatment Technologies* for more detail.

- **Energy capture:** The number of resource recovery plants which generate heat, biogas and other resources will vary depending on the size of the municipalities. Smaller municipalities might combine their waste sources to service a single regional plant, while in the larger centres several such plants may be required to optimise the net revenues. These will vary in size and will be located close to where heat can be distributed using neighbourhood (district) heating loops. The treatment plants are relatively small and can be located in basements of large commercial buildings or underground, if desired, but a mixture of surface and subsurface is preferred.

Raw Sewage

Raw sewage can be treated initially at the neighbourhood level in small plants that would occupy an area smaller than a normal house, and which would likely be located underground, similar to current pump stations. Heat can be extracted by heat pumps to provide a carbon neutral source of heating for commercial and institutional facilities. The cold, treated water leaving the heat pumps can provide a source of cooling to these same facilities.

Tertiary treated water would be disinfected and used to recharge groundwater and improve stream flows in dry areas of the province, or can be used in other applications (for example commercial use, subject to regulatory compliance). Energy requirements for pumping residual treated water and sludge to more centralised waste treatment sites will thereby be reduced.

The use of treated sewage as a resource, generating electricity and reducing use of fossil fuels is consistent with reducing greenhouse gases, *i.e.* is consistent with government policy commitments at all levels.

Wet Organic Wastes

Wet organic waste can be processed in anaerobic digesters to produce a significant amount of energy. Wet organic wastes come from households, commercial and institutional facilities, if separated and collected together with residual sludge from treatment plants, can be converted to a biofuel in anaerobic digesters. These digesters are based on well-established and available technology, and would optimally be centralised facilities in larger centres, or located in places that could serve a number of smaller municipalities. The biofuels could be used by vehicle with engines converted to burn natural gas or could replace fossil fuels for heating.

Removal of organic wastes from landfills would eliminate production of new sources of methane gas from landfills in the future. Over time, the methane gases from existing organic wastes in such landfills can also be captured, if the landfills themselves are not "mined" to recover resources.

Dry Organic Wastes

Garden wastes combined with residuals from digesters and any other dry organic waste can be converted into a synthesis gas in gasifiers and which is then used to generate electricity and heat through co-generation facilities. Such facilities, which also use readily available technology, could also be centralised to service larger municipalities or groups of smaller municipalities.

Metals and minerals contained in the residual material from the co-generation facilities can be sent to refining facilities to recover metals. As a consequence of deploying the full IRM model, it is possible to reduce or potentially eliminate solid waste to landfills.

This report did not consider the potential to incinerate residual garbage from the waste stream. This technology is available and viable, although it would require significant public consultation before it could be deployed. If undertaken, almost the entire solid waste stream could be eliminated and existing landfills gradually mined for their resources and then converted to more beneficial land uses.

Unique Features of IRM

Table 1: How IRM Differs from Traditional Waste Management on page vi demonstrates some of the ways in which the IRM approach differs from the more traditional approach to wastewater management. The distinctive features and benefits of the distributed IRM approach are that it:

- Provides a new localised source of carbon neutral heat. The average winter temperature of sewage measured at the Macaulay Pt. and Clover Pt. outfalls in the Capital Region is 17°C. Heat can be recovered from this water by means of heat pumps, and used to displace fossil fuels and electrical heating in nearby buildings without the costs of ground-source (geothermal) systems. Once heat energy is extracted, the cold water is a source for air conditioning and refrigeration. The most efficient model for IRM is to locate treatment plants adjacent to clusters of commercial, residential and institutional buildings that can use the heat and cold, including hospitals and university campuses;
- Provides a new source of treated water that can recharge creeks and groundwater, irrigate public spaces, and offset potable water use for non-potable purposes including residential irrigation and toilet flushing;
- Takes advantage of new innovative technologies as they are developed because they can be undertaken on a flexible time scale, where needed and as circumstances permit, to minimise costs;
- Takes advantage of, and contributes to, more aggressive water conservation policies associated with green building code and other provincial policies in water-short regions of the province and thus reduces the costs for pumping and treating sewage;
- Eliminates wastewater biosolid (sewage sludge) dumping at landfills;
- Potentially reduces overall costs for sewage treatment in the Province due to these features noted above, especially where additional treatment capacity is required in the near term;
- Reduces energy use and creates new, greenhouse gas neutral energy sources to assist in meeting the Province's energy conservation targets; and,
- Is an integrative, GHG-positive, zero-waste approach to wastewater management that is therefore most compatible with the principles of the Brundtland Report, *i.e.* "*...meeting the needs of the present without compromising the ability of future generations to meet their own needs.*"¹⁵

The difference in approach taken by IRM and the impact on optimising wastewater is driven by the highest and best use and value business case, which can be illustrated by an example:

¹⁵ Brundtland Commission "[Report of the World Commission on Environment and Development](#)", United Nations, 11 December 1987.

While diverting organic solid waste to composting facilities instead of to landfills does reduce greenhouse gas emissions and landfill leachates, it may not maximise value. This is because higher value could be obtained by selling fuel if the waste was converted to fuel instead of to compost. Using biogas also avoids using fossil fuels and thus has additional benefits in reducing greenhouse gas emissions and pollution. Where the fuel is turned to electricity there is value in meeting BC Hydro's energy generating needs. In addition, the nutrient value of organic waste is still available after biogas digestion. Thus, composting while relevant in certain circumstances, may not optimise the highest and best use and value in many IRM scenarios. Figure 4 and Figure 5 below illustrate the principle of "highest and best use" in the IRM model, achieved through an integrated understanding of the net business case for resource recovery.

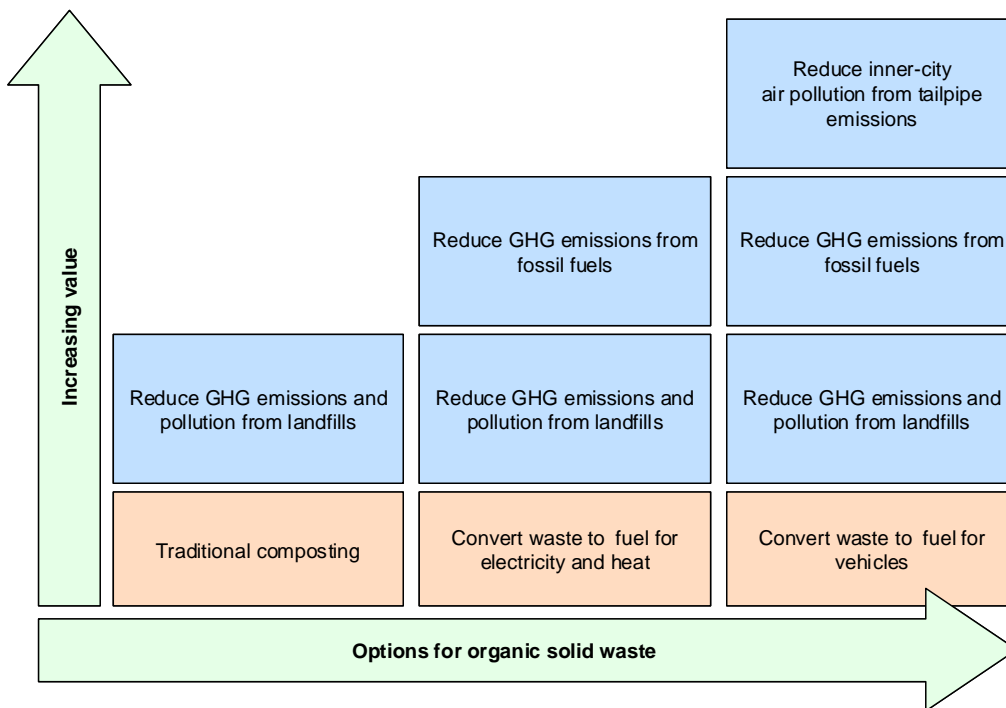

Figure 4: Highest and Best Use Matrix for Organic Solid Waste

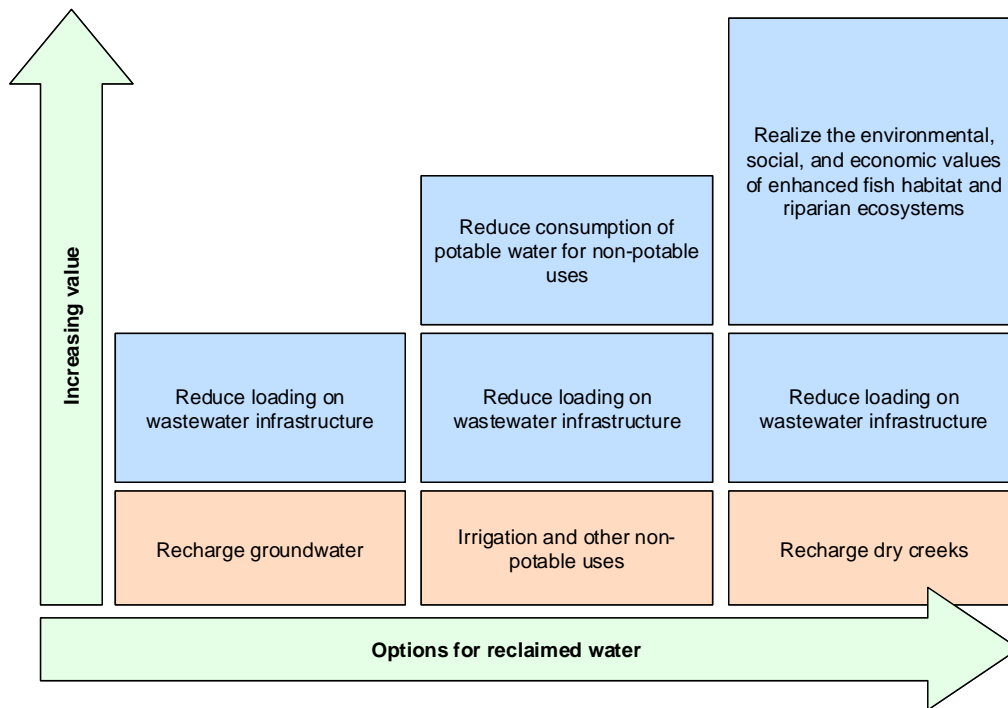

Figure 5. Highest and Best Use Matrix for Reclaimed Water

Role for IRM in British Columbia

IRM, as developed by the Study Team, is a concept that can be adapted to a variety of circumstances, in rural, suburban and urban settings. It must however, be adapted to local needs if it is to be optimised. The model developed cannot be "photocopied" and assumed to work.

From testing the model, the only main condition that would restrict its wider use is where there is insufficient density of population. In those circumstances it could be implemented, but would probably not be viable and GHG yields etc. would change. Such smaller installations may still be considered, however it will in most instances be marginal compared to septic installations, which have a lower cost.¹⁶ The smallest community installation we are currently aware of is 85 homes for separation and treatment, with recovered resources trucked off site.

¹⁶ Septic fields produce off-gassing that contributes to climate change. While the amount is small on an individual basis, the number of such fields are significant. If this unpriced ecological impact is taxed, it would tend to shift the economic balance.

There are therefore many opportunities to apply an IRM approach in British Columbia:

- Most local governments in British Columbia have sewage treatment plants and associated infrastructure together with a financing structure to retire the debt. However, many centres require either upgrades to these systems or expansion to accommodate population growth. In Metro Vancouver for example, plans are underway to upgrade the Lions Gate and Iona wastewater treatment plants from primary to secondary treatment. As these plans are developed, the costs and benefits of an IRM approach could be considered;

Figure 6. District Heating Loop in Gothenburg, Sweden



- On Vancouver Island and in the BC Interior, cities will be replacing their wastewater treatment infrastructure over time, and could consider the costs and benefits of an IRM approach before re-investing in conventional, centralised treatment plants. This will especially be true where there is deferred maintenance, ageing infrastructure, plants or equipment, or where there is limited funding and/or concern to limit tax increases. Since IRM can be deployed relatively quickly, it will be suitable where emergency replacement is required. Older communities can be retrofitted to adapt to IRM. It is not solely dependent on new development to be implemented;
- Cities that face water shortages will benefit from IRM planning to maximise the amount of reclaimed water which is recovered. For example, the community of Tofino ran out of potable water in Summer 2006, and has recently been ordered to implement secondary sewage treatment. An IRM approach could contribute to solving both these problems;
- Cities with limited options for sewage disposal could benefit from the IRM approach of land-based discharge. The BC Ministry of Environment, for example, has recently extended a moratorium on further expansion of sewage disposal into Shuswap Lake. IRM is more suitable for deployment where there are sensitive ecological areas or environmental concerns as it can be designed to have a low ecological footprint. This is usually a concern for communities;
- The Village of Chase has recently been awarded a grant for upgrading its lift pump systems under the Canada-BC Rural Infrastructure Fund. This fund could be used to support IRM in rural communities;
- Many watersheds in the Interior suffer from water shortages in the late summer where stream flows are insufficient to accommodate ecological requirements—fish flows, water quality, riparian integrity and the needs of irrigated agriculture and growing communities. IRM offers an

opportunity to replace water diverted from streams for municipal purposes with reclaimed water, in order to sustain minimum flows required for ecological function. There is a further opportunity to increase carbon sequestration through greening of these watercourses;

- In the discipline of industrial ecology, waste energy, water, and material streams are exchanged between industry and communities. Cities in the BC Interior could apply this eco-industrial planning by:
 - Investigating the costs and benefits of extracting heat energy from industrial wastewater. The volume of treated effluent from a single pulp mill for example can be approximately equal to the total flows of sewage from a city of 300,000. Since pulp mill effluent is significantly warmer than municipal wastewater, this source represents a very large energy opportunity. Other examples exist.
 - Combining resource recovery from municipal waste streams with other biofuel projects such as cogeneration from gasification or burning of pine-beetle-killed wood;
 - Using the ash from biomass combustion in fly-ash cement, as a means of reducing the greenhouse gas emissions from cement manufacturing.
- Synthesis gas from the gasification of municipal organic waste can be reformed into hydrogen for use in the "Hydrogen Highway," thus reducing dependence on fossil fuels;
- Biogas from anaerobic digestion of organic waste can be reformed into hydrogen or into liquid fuels such as ethanol for blending with gasoline, or the methane in biogas can be upgraded and used in cars and trucks. Trucks, buses, and other heavy vehicles can be ordered from the factory with engines adapted to burn methane. Existing vehicles can be converted to burn methane, but at additional cost. Biogas-powered cars and buses are common in Europe.

This Phase 1 study did not include a . detailed analysis of the application of IRM in rural situations, although interpretive comment is provided. However there are situations where developers of new sites are interested in applying the IRM principles to their projects, such as the Westhills Project in Langford. In these cases, time is of the essence as developers and design teams require early direction from the Province and the appropriate local governments, that these jurisdictions are supportive of the IRM approach. If this direction is not forthcoming in the near future, these developers will be forced to apply traditional approaches to designing their water and waste systems and thereby lose the opportunity to contribute directly to

Figure 7. Biogas Powered Bus in Sweden



the Premier's policy announcements about fast-tracking green developments.

IRM can thus be said to enable development in some locations, which would be more expensive to address if traditional approaches were used.

IRM Policy Comparison

Integrated Resource Management has the potential to make a significant contribution to many of the Province's climate change and green city commitments:

- *Weather, Climate and the Future: BC's Plan*¹⁷ (December 2004), containing 40 action areas for greenhouse gas (GHG) reduction.
- The Greenhouse Gas Reduction Targets Act, November 2007.
- Participation in the North American Climate Registry¹⁸ (as of May 2007), a system for tracking GHG emissions with policies for GHG reduction.
- Commitments made during the Premier's speech to UBCM¹⁹ (October 2007), including:
 - Reduce GHGs by 33% by 2020 from current levels with legally binding interim targets for 2012 and 2016;
 - GHG targets to be legally incorporated into OCPs and regional growth strategies;
 - Development cost charges to be amended to encourage green developments;
 - Faster approvals for green developments;
 - Municipalities and home owners to be encouraged to save energy and water;
 - Encourage green technology through a clean energy fund;
 - Reducing the carbon intensity of fuels;
 - BC leadership in green technologies and professional services; and,
 - Regulate landfills to use methane beneficially and reduce trucking of biosolids to landfills.
- BC's participation in the International Carbon Action Partnership (October 2007).
- The BC Climate Action Charter²⁰ that addresses:
 - Removal of legislative, policy and regulatory barriers to taking action on climate change;

¹⁷ Available from <http://www.env.gov.bc.ca/air/climate/index.html>

¹⁸ Available from <http://www.env.gov.bc.ca/air/climate/index.html>

¹⁹ Available from [provincial government web site](#).

²⁰ Available from http://www.cserv.gov.bc.ca/ministry/docs/climate_action_charter.pdf

- Land use policies to increase density and reduce urban sprawl;
 - Encouraging district energy systems;
 - Encouraging conversion to biodiesel fleets;
 - Organic waste recovery;
 - Recycling and waste management plans;
 - Green roof policies;
 - Grey water recycling and standards for re-use; and,
 - Sustainable community servicing plans.
- BC's *Energy Plan*²¹ (February 2007) supports the production of clean energy, including waste energy capture and utilisation.
 - Province's environmental management objective for improving water quality and providing the 'best fisheries management bar none'.
 - Provincial bioenergy strategy which includes a \$25 million fund to establish a provincial Bioenergy Network to encourage investment in bioenergy projects and technologies.
 - Establishment of the Pacific Institute for Climate Solutions with a \$94.4 million fund to support innovative climate adaptation and mitigation solutions.
 - Provincial Transportation Plan which includes investment in busses fuelled by non carbon energy.
 - Provincial 2008 Budget introducing a carbon tax on all fossil based fuels.

A more complete listing of senior and local government policies relating to GHG reduction, alternative energy, sustainable waste management and innovative technologies is provided in *Appendix C: Government Policies and Commitments*.

²¹ Available from <http://www.energyplan.gov.bc.ca/>

Resource Recovery Technology and Opportunities

Treatment Technology

Sewage must be treated before water and energy can be recovered. The Study Team has developed a conceptual model for a distributed sewage treatment network, comprised of several small, decentralised plants. This decentralised approach allows the plants to be located close to their future clients for recovered energy and reclaimed water.

The final number of plants and the size of individual plants can be optimised to suit the needs of the community. For the purposes of this study, we have looked at plants with a capacity of 2,500m³/day, along with a smaller number of higher capacity plants (20,000 m³/day, 10,000 m³/day and 5,000 m³/day). To help understand the scale of the plants, a 2,000 m³/day plant would handle the sewage from approximately 8,800 people, and would require a total footprint of 300 m² (3,200 square feet). These could be built in several levels underground, thus minimising the net footprint.

One option is to locate these small, decentralised plants on, at or near existing sewage lift stations, taking advantage of existing infrastructure, rights-of-way, and land already owned by municipalities. This system could be thought of as a network of sewage treatment plants, analogous to many interconnected machines working together, as opposed to a single machine (mainframe computer, or centralised treatment plant in this case).

A distributed network can be more robust in the event of failures of individual pieces of equipment as loads can be shifted to other plants when one is at capacity or failing. The plants would be monitored and controlled automatically and remotely, in conjunction with appropriate on-site inspection, monitoring and maintenance. A more detailed description is provided in *Appendix D: Waste Treatment Technologies*.

Resource Recovery

There are many ways of recovering energy from sewage and organic solid waste, including esterification of waste oil to biodiesel, gasification of dry organic waste to synthesis gas, and anaerobic digestion of wet organic waste to produce biomethane (methane from biological rather than fossil sources). Methane is a building block molecule from which other fuels such as ethanol can be produced. Although this

study only examined the energy value of waste, it is possible that recovered biofuels will have higher value as replacements for petrochemicals rather than as fuel.²²

As a starting point, the Study Team selected four well-established resource recovery pathways for the IRM model in this study:

1. Reclamation of highly-treated water for beneficial uses;
2. Recovery of heat energy via heat pumps for district heating and cooling;
3. Recovery of methane from wet organic waste for use in buses and cars; and,
4. Recovery of synthesis gas from dry organic waste for production of electricity and heat.

More detail on resource recovery technology is provided in *Appendix F: Energy Recovery*.

Water Conservation and Recovery

Water is arguably our most precious resource. As such, many jurisdictions recognise the economic and ecological value of reclaiming wastewater. In the U.S., California, Texas and Florida are leaders in the field of water reuse and Washington State has had a water reuse standard since 1992. Washington's Water Reclamation and Reuse Standards were completed in September 1997 through the cooperation of the Departments of Ecology and Health and are some of the most comprehensive in the United States.²³ Though minimum standards for water reuse are established under BC's Municipal Sewage Regulation (1999), water reuse is still uncommon in BC, except for the purposes of irrigation in communities such as Vernon, Cranbrook and Osoyoos where reclaimed water has been used since the 1970s and early 1980s.

Both groundwater and surface water supplies in parts of the province are at risk from over-allocation. From an ecological perspective, IRM and water reuse provide opportunities to create closed-loop water systems with significant ecological benefits. In most urbanised areas, water for human use is diverted from surface streams (which are ultimately fed by groundwater) or extracted through groundwater wells in large quantities for commercial and household uses. Rarely is water returned to the groundwater system in volumes that are similar to natural infiltration conditions. Coupled with decreased groundwater recharge due to the expansion of impermeable surfaces in the form of buildings, roads, sidewalks and parking surfaces, many jurisdictions have now been 'mining' the groundwater for so long that the water table has dropped to critical levels.²⁴ Many urban streams currently suffer from extreme summer low flows, and subsequent elevated stream temperatures, decreased oxygen levels and fish kills

²² Who Needs Oil? New Scientist, July 7-13, 2007

²³ Washington State Department of Ecology. 2000. Water reclamation and reuse. The demonstration projects. Publication Number 00-10-062. 16 pp.

²⁴ Washington State Department of Ecology. 2000. Water reclamation and reuse. The demonstration projects. Publication Number 00-10-062. 16 pp.

due to urbanisation and water withdrawals. Climate change, which may cause greater weather extremes in most regions, may further exacerbate the already critical condition of many aquatic systems. If high-quality treated effluent was available to replenish surface water and groundwater, this could help to alleviate some of these concerns.

Perhaps the most ecologically important “use” of reclaimed water, is that its reuse in any form takes pressure off of the potable water supply and allows water to remain in the lakes, creeks, and rivers to meet the needs of the aquatic organisms that inhabit them. For activities where drinking water is used for non-potable purposes—such as irrigation, washing cars and flushing toilets—use of reclaimed water can help to reduce the demand for drinking water, and the costs of providing it.

Small and decentralised wastewater treatment presents more opportunities for water reuse, as treatment sites can be located where water is most appropriately reused. Wastewater can be treated to a quality that is appropriate for the specific type of reuse, ranging from irrigation of crops to toilet flushing. When considering the best use for treated wastewater, the risks and benefits (economic, ecological and social) of each option should be weighed. The selection of options is dependent upon volume, climate, assimilative capacity of receiving waters and soils, and quality of the treated wastewater. In the context of IRM, not only should treatment plants be located such that water could easily be reused or dispersed, but also located such that other resources such as heat, biosolids and energy could also be readily utilised close to source.

District Heating & Cooling

The energy in sewage can be captured and used for heating and cooling nearby buildings, using heat pump technology. Heat pumps operate on the same principle as refrigerators and air conditioners, extracting heat energy from a low temperature source, and making it available at a higher temperature. Heat pumps are gaining popularity because they can yield four units of heat energy for every unit of electrical energy consumed. Heat pumps normally extract heat from outdoor air, or from ground-source piping, neither of which is as economically efficient to obtain as heat from sewage.

An advantage of sewage heat pumps is that no ground-source piping is required, further reducing the cost of providing energy in this way. Treated sewage from local treatment plants can be piped to heat pumps which could either be located in an energy provider's facility, or in a commercial building.

IRM requires a careful cost/benefit analysis to be undertaken to assess the optimal way to recover energy, to fit localised needs. The system flows are diagrammed in Figure 8 and Figure 9 on page 24.

Once heat energy is extracted from treated sewage, the effluent is cold enough to be useful for refrigeration and air conditioning through district cooling networks. Stores and commercial buildings can use this cold water to replace refrigeration and air conditioning equipment, resulting in lower electricity consumption operating and maintenance costs.

In cities where sewage treatment is centralised, opportunities for recovery of heat energy from treated sewage are limited. The IRM strategy used in this study places small, local treatment plants next to clusters of commercial or institutional buildings which can use the heat and cold.

Figure 8: District Heating & Cooling Loops

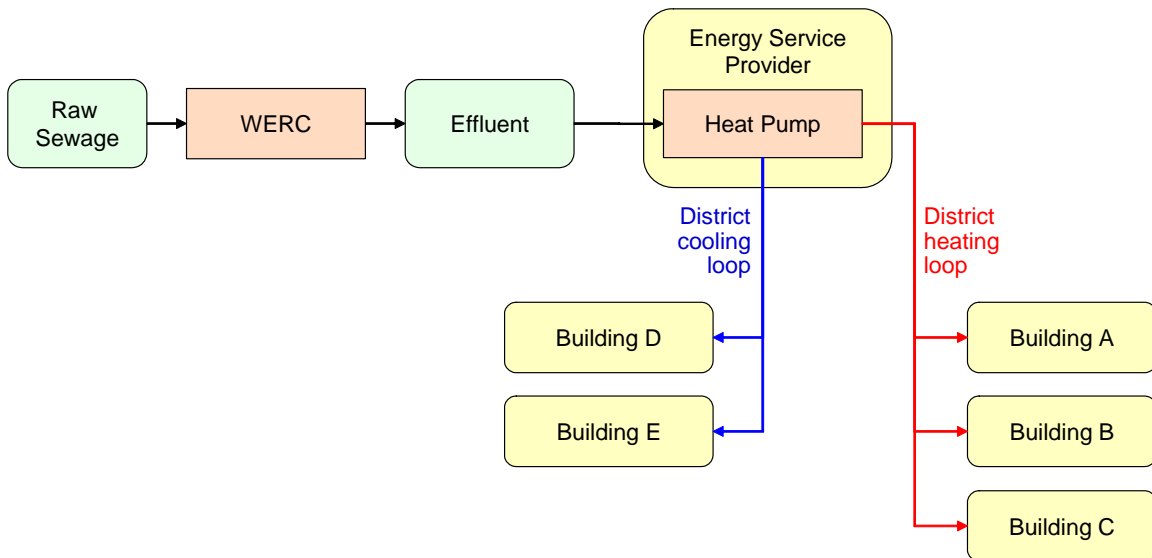
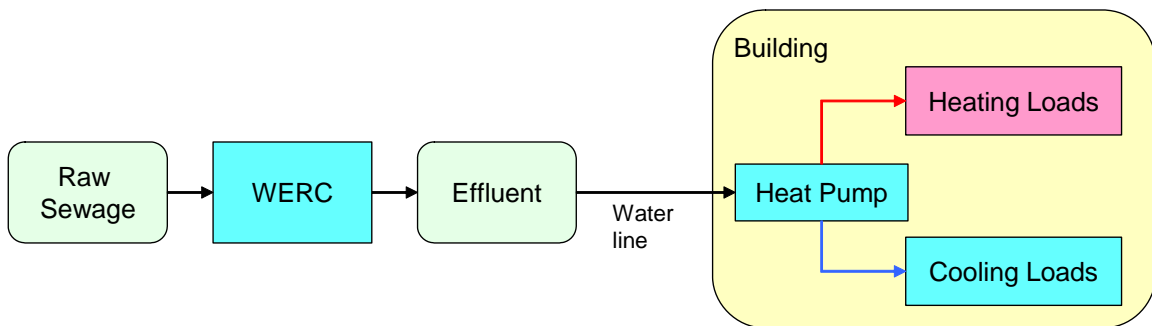

Figure 9: Building Heating & Cooling Distribution



Revenues from Biogas

There are several options to secure revenues from biogas; it could for example be sold into an existing gas pipeline as the output is proposed to be natural gas. However the revenues from this, and the amount of carbon displaced from competing potential revenue sources suggested that it would not be optimal.

An alternate option is to burn the gas to generate electricity. This suffers energy conversion loss and is not considered likely to yield the highest and best value. It would not maximise carbon reduction.

We concluded that biogas would be better directed towards displacing gasoline or diesel. The lessons of how this has been implemented elsewhere confirmed the IRM model's predictions, including the Swedish example and implementations in Brazil. We thus concluded that creating biofuels for vehicles (cars and buses) would optimise the benefits. Discussions with energy service providers also confirmed this.

The difficulty with this is that gas distribution must be considered. In Sweden, the gas is directed to the general natural gas network and then extracted at the point of sale. Sweden also has dedicated pumps and transmission systems. Brazil also has general distribution systems, however their approach is larger scale and more biogas would likely be needed to make this viable.

BC is fortunate to have a well-developed natural gas distribution infrastructure. Methane from biogas digesters could either be piped directly to large customers such as transit bus filling stations, or the methane could be distributed to users through the existing natural gas distribution infrastructure. Although this "green" methane would be mixed with fossil methane in the pipeline, the net effect would be analogous to an electrical distribution system receiving and distributing electricity from green sources.

In terms of pricing and to ensure maximum take-up of biogas, the IRM model assumes biogas will be sold at a discount below the price of gasoline and diesel, in order to provide an incentive for vehicle owners to convert to this form of fuel.

Anaerobic Digestion for Biogas

In larger sewage treatment plants, it is common for sludge to be processed in anaerobic digesters to produce biogas, which is a mixture of methane and carbon dioxide. The biogas is normally burned to produce heat and electricity for the plant, thus reducing its overall energy requirement. In Swedish treatment plants, however, it is becoming more common for these digesters to process organic solid waste (often referred to as compostable waste, or kitchen waste) as well, in order to produce significantly more biogas. In Stockholm, kitchen waste is delivered not to a landfill but to the Hendriksdals sewage treatment plant, where it is co-treated with sewage sludge to produce enough biogas to run 50 local buses today, a number which will rise to 200 buses by 2010.²⁵

The IRM model is based on operating one or more biogas digesters which will accept sewage sludge as well as all other streams of *wet* organic waste in the model. Anaerobic digesters receive wet organic waste such as sewage sludge and kitchen waste, and rely on methanogenic bacteria to decompose the waste in the absence of oxygen. This raw biogas can be upgraded to methane of natural gas pipeline quality, indistinguishable from natural gas. This methane (sometimes referred to as "biomethane") can be fed into natural gas pipelines, or burned in cogeneration plants, buses, or cars.

²⁵ Personal communication between Stephen Slater PEng and Dr, Marta Tendaj, Business Development Manager with Stockholm Vätten, October 2006.

The residual matter from biogas digesters is very high in inorganic materials, since the nutrients are concentrated as organic materials are converted into methane. Although this residue can be composted and used as fertiliser, complications of land application of sludge residues include questions of accumulation of metals and other contaminants in soils. In the IRM model under study, this residual matter is added to dry organic waste (for example wood waste) and processed into a different form of fuel (synthesis gas or syngas) in a gasifier.

Gasification for Syngas

Gasification is the process of decomposing organic solids such as wood waste at high temperatures, with little or no oxygen. Under these conditions, long-chain molecules such as cellulose break down into methane, hydrogen, carbon monoxide, and carbon dioxide. This mixture, called synthesis gas (often abbreviated to "syngas"), is not suitable for storage as transportation fuel, but can be burned for heat or burned in a cogeneration plant to produce electricity and heat. In BC, the Tolko plywood mill near Kamloops has recently installed a gasifier which converts wood waste into syngas, which displaces natural gas in the company's drying operation.²⁶

Chemicals, Metals and Other Resources

Sewage also contains potentially harmful bacteria, chemicals and other components, including heavy metals that can make it difficult to utilise the sewage. Normally these are viewed as a problem; however, these too can be separated, reused and recycled as resources.

The residue from gasification is ash, which can take the form of a vitreous solid in which metals are bound and cannot readily leach into the environment. This material has been used as a road base, but could be included with ore for smelting by mines. The CTMP pulp mill in Chetwynd, BC produces a similar ash from standard combustion of its wastewater solids. This ash is currently sent to a mine in New Brunswick for refining into metals, however the economics of this approach are unknown.²⁷

The IRM model does not include revenues from metals, minerals or fertiliser.

IRM Implementation Strategy

The full benefits of integrated resource management are realised when all elements are implemented in concert. The Study Team recognises however, that depending on the circumstances of a given community, it may be desirable to implement one or more elements in advance of others. The options below are not intended to show a sequence in time, but are intended to show options for municipalities. A given municipality may benefit from working on several of these options at the same time.

²⁶ Wood Residue to Fuel. July, 2006. Biomass Magazine.

²⁷ Per Fred Stock, Steam Plant Manager, Tembec, Chetwynd BC, 2006

- **Increase biogas production** at existing wastewater treatment plant (WWTP) anaerobic digesters by combining wet organic waste streams with the sludge. The equipment is already in place and could be converted to accept wet organic wastes. An example is the Annacis Waste treatment plant in Metro Vancouver.
- **Build new anaerobic digesters** in municipalities with inadequate existing equipment to combine wet organic waste with sewage sludge for producing biofuels for vehicles or burn in cogeneration plants for electricity and heat. This approach would apply in the CRD, for example. Both of these steps would enable the province to make a significant contribution to reducing GHG emissions but would require source separation of wet organic waste from households and businesses. It would also eliminate release of new sources of methane from existing landfills as the waste which is source of this methane would be diverted to digesters.
- **Build new gasifiers** to process dry organic waste into synthetic gas to burn in cogeneration facilities for electricity and heat. This would be a new source of carbon neutral electricity. The technology is readily available and could be deployed in municipalities that already collect garden wastes and organic construction material.
- **Apply IRM to new developments.** This is starting to happen, *e.g.* at Dockside Green. There are a number of other developers willing to apply the IRM model such as Vantreight Farms in Central Saanich. The optimal application of IRM will benefit from changes to the building code to apply water conservation, water reuse, energy to waste facilities and discharge of treated water to groundwater aquifers and, in some cases, changes to municipal zoning bylaws.
- **Retrofit neighbourhood heat recovery/wastewater treatment** plants where there is a ready market. This component could be applied to provide heat to public institutions which are required to become carbon neutral by 2010. An example is the University of Victoria which has a centralised heating system that could be readily converted to heat pumps.
- **Retrofit distributed heat recovery and waste treatment** plants to municipalities that either have no treatment plants or municipalities that require a major upgrade or expansion of existing treatment facilities such the City of Cranbrook. Apply IRM where treatment does not exist, such as the Core Area of the Capital Region.
- **Apply IRM to communities needing infrastructure upgrade or replacement**, such as Metro Vancouver's Iona and Lions Gate WWTPs, for example.
- **Apply the IRM model to communities that are short of water.** This component would provide reusable treated water to replace potable water for non-potable uses. It can also recharge groundwater sources and increase instream flows for fish passage in the summer and fall and to improve the ecological capacity of watersheds to absorb carbon. Examples include many interior streams and rivers and some on the East Coast of Vancouver Island such as the Cowichan River. The costs of such projects might be provided by funds from the carbon trading market to provide new sources of carbon sequestration to offset carbon emissions from sources that cannot reasonably meet the GHG reduction targets set in provincial legislation.

It will not always be practical for local governments to apply all aspects of the IRM model and business case. Local governments will have to weigh the costs, benefits and risks associated with changing their current infrastructure against the gains for accessing revenues and meeting their targets for GHG reductions if they have signed onto the Community Action Charter. One of the tasks for the implementation phase will be to design a more detailed road map to assist local governments in identifying the most effective measures of IRM that fit into their specific circumstances.

Capital Region Example

Sewage Treatment in the Capital Region

The Study Team was to "*determine the feasibility of more sustainable and integrated approaches to wastewater management and resource recovery for communities in British Columbia*", using the Capital Region as a case study. This section sets out an approach which could be used in the Capital Region, and provides conservative estimates of the costs and potential revenues from an IRM approach. There are several limitations in this analysis, because it has been developed at the conceptual level. The Study Team has had neither the time nor resources to undertake the level of engineering assessment that has been undertaken to-date by the CRD. Consequently, the estimates of costs and benefits provided in this section should not be compared directly with those provided by the CRD.

The CRD is actively engaged in a planning process for wastewater treatment for its Core Area. The CRD Core Area Wastewater Management Program²⁸ is for all or parts of the municipalities of Victoria, Oak Bay, Esquimalt, Saanich, View Royal, Colwood, and Langford. Other parts of the Capital Region have separate treatment systems or are serviced by septic fields.

The Minister of Environment provided the CRD with direction in December 2007 regarding the next steps in amending its liquid waste management plan. This included the following components which are consistent with the IRM approach:

- Examine opportunities to maximize resource recovery through a more distributed infrastructure model;
- Consider integrating solid and liquid waste resource recovery opportunities;
- Aggressively pursue opportunities to reduce GHG emissions; and
- Optimize smart growth results.

The IRM approach considers all these factors by maximising the potential to recover resources from waste, by evaluating the long-term costs and benefits of addressing the region's solid waste, water, energy, transportation, and greenhouse gas issues along with liquid waste.

²⁸ CRD. 2007. Core Area Wastewater Management Program: The Path Forward. Prepared by Associated Engineering BC Ltd., CH2MHill and KWL.

Wastewater Treatment Infrastructure

Distributed Treatment Plants

The business case for IRM in the Capital Region was based on a system of 32 distributed treatment plants, with between one and three sites for biogas generation and synthesis gas production. The majority of the load (56%) would be distributed among 28 small treatment plants, with the balance of the load handled by four somewhat larger plants for a total of 32 plants.²⁹

This distribution scheme is just one of many configurations that are possible for the Capital Region, and was chosen for modelling purposes only. A detailed analysis will be needed to determine the ideal number, size, and distribution of plants, in order to optimise the environmental, economic, and social benefits of IRM.³⁰

Please see *Appendix D: Waste Treatment Technologies* on page 87 for more detail concerning the design of the distributed wastewater treatment plants in the IRM model.

Figure 10: Possible Load for Capital Region IRM Treatment Plants

Plant	Number of Plants	Percent of total load
Extra-large	1	21%
Large	1	10%
Medium	2	10%
Small	28	2% each, <i>i.e.</i> 56% total

Biogas Digesters and Gasification Plants

In the IRM model, between one and three biogas digesters would be operated in the Capital Region. These digesters would operate in the more efficient thermophilic range rather than the mesophilic temperature range which has been the default in North America. Sludge and organic waste would be pre-treated to increase digester yields by means such as ultrasound, hydrolysis, or high-pressure homogenizers.

²⁹ For comparison, the current CRD proposal would see 69% of load treated at Macaulay Point, 19% of load at the Westshore B site, and 12% at the Saanich East site.

³⁰ Note that in all likelihood, the number of plants would ideally be higher (*i.e.* more and more localised), to further reduce transportation of separated/treated effluent.

The IRM model is based on operating one or more gasification plants, which will accept residues from the biogas digesters, as well as all other streams of dry organic waste (e.g. yard and garden waste, paper, wood).

Leachates

In addition to the biogas digesters, a dedicated plant would be required at the CRD's Hartland Landfill to process leachate, with the potential benefit of abandoning the 15 km leachate pipeline which currently carries untreated leachate to the sewer system and discharges through Macaulay Point. A plant at Hartland could be tailored to address the specific mix of toxins in landfill leachate, which have been well-characterised by CRD studies. Five million dollars have already been set aside by the CRD for this plant. Further study would clarify whether Hartland or an alternate location might improve recovery efficiency.

Energy and Water Recovery from Wastewater Treatment

District Heating and Cooling

Heat and cold could be provided from treated wastewater in two ways: multiple local district energy systems, and building-based heat pumps.

Multiple Local District Energy Systems

In this option, heat pumps would extract energy from treated wastewater, and deliver the energy to users through a network of insulated water pipes — a district energy system. After heat energy has been removed from treated wastewater, the effluent temperature is near freezing. This cold water can be run through efficient water-to-water heat exchangers to provide chilled water suitable for air conditioning and process cooling. The chilled



Figure 11: Lonsdale Energy Corp. District Loop Illustration

water would then be distributed through insulated district cooling pipes to nearby buildings. Wherever possible, district energy pipes could be installed in conjunction with road work by utilities (water, gas, phone, etc.) in order to reduce cost.

The advantage of this approach is that surplus heat or cold from one building can be carried by the district energy pipes to buildings where it is needed. This approach creates the possibility of a “net metering” system that can allow subscribers to exchange their excess heat and cold with each other. No revenues from net metering have been factored into the IRM analysis.

Table 5 and Table 6 show how district heating can offer opportunities for both heating and cooling at different times of year.

Building-based Heat Pumps

In this option, decentralised treatment plants would be located close to an energy client, and the plant could be sized to take into account the client's need for energy. A single water pipe would deliver treated effluent to a client's building, where water-source heat pumps would extract heat energy and would simultaneously chill the water to provide cooling through water-to-water heat exchangers. After heat and cold have been extracted from the water, it could be used for non-potable water purposes on the client's premises, or discharged (please see the Water Reuse section of the report).

This strategy results in a lower cost of implementing IRM; pipes to carry treated effluent to a nearby building are much less expensive than insulated district heating and cooling pipes, and shorter, since treatment plants would be located near energy users. This option also reduces energy losses through district heating pipes, which carry water at 60–70°C, compared with the much lower temperature of treated wastewater.

Table 5 and Table 6 summarise *Potential District Energy Winter Loads in the Capital Region* and *Potential District Energy Summer Loads in the Capital Region*. Note that if both heating and chilled water are considered, the most valuable loads will be 'winter cooling' and 'summer heating'.



Figure 12: Heat Pump at Pacific Sands Resort, Parksville

Table 5: Potential District Energy Winter Loads in the Capital Region

WINTER			
HEATING LOADS		COOLING LOADS	
SITE	LOAD	SITE	LOAD
Victoria General Hospital / Laundry Spectrum School Pacific Forestry Centre	Space heat & DHW Space heat & DHW Space heat & DHW	Victoria General Hospital G.Pearkes Arena	MRI's, CAT Scanners Ice Rink
Camosun College - Interurban Vanc Is Technology Park V.I. Regional Correctional Centre Saanich Municipal Hall	Space heat & DHW Space heat & DHW Space heat & DHW Space heat & DHW	Save-on-Foods Supermarket	Low & med. temp condensers
CFB Esquimalt Esquimalt Pool	Pool Space heat & DHW Pool Space heat & DHW	Esquimalt Arena CFB Esquimalt	Ice rink condenser Ice rink condenser
Juan de Fuca Recreation Centre Priory Hospital	Pool Space heat & DHW Pool Space heat & DHW	Juan de Fuca Arena	Ice rink condenser
Mayfair Mall	Space heat & DHW	Workplace Technologies Services	Data centre cooling
Crystal Pool Victoria Police Station Vic City Hall / McPherson Playhouse Office Buildings	Pool, space and DHW Space heat & DHW Space heat & DHW Space heat & DHW	Save-on-Foods Arena Victoria Curling Club Agropur - Island Farms Dairy Telus and other switching stations	Ice rink condenser Ice Rink condenser Low & med. temp condensers Data centre cooling
Legislative Precinct Royal BC Museum Empress Hotel Pacific Grande Hotel	Space heat & DHW Space heat & DHW Space heat & DHW Pool, space and DHW	Royal BC Museum	Dehumidification/space cooling
Royal Jubilee Hospital Oak Bay Recreation Centre Oak Bay Lodge Aberdeen Hospital Camosun College - Lansdowne	Space heat & DHW Pool, space and DHW Space heat & DHW Space heat & DHW Space heat & DHW	Royal Jubilee Hospital Safeway Oak Bay Arena	MRI's, CAT Scanners, data centre Low & med. temp condensers Ice Rink condenser
UVic	Space heat & DHW	Racquet Club Arena	Ice rink condenser
AS APPLICABLE: Condo/Apt DHW Pre-heat Schools Hotels Restaurants	DHW Pre-heat, pools Space heat & DHW Space heat, DHW, pools Space heat & DHW	Supermarkets Restaurants	Low & med. temp condensers Low & med. temp condensers

Prepared by Bob Landell, AS&T, LEED® AP of Avalon Mechanical Consultants Ltd.

Table 6: Potential District Energy Summer Loads in the Capital Region

SUMMER			
HEATING LOADS		COOLING LOADS	
SITE	LOAD	SITE	LOAD
Victoria General Hospital Pacific Forestry Centre	DHW & laundry process DHW	Victoria General Hospital Pacific Forestry Centre Pearkes Arena	MRI's, CAT Scanners Space cooling Ice rink condenser
Camosun College - Interurban V.I. Regional Correctional Centre	DHW DHW	Vanc. Is. Technology Park (VITP) Saanich Municipal Hall Save-on-Foods Supermarket	Space cooling Space cooling Low & med. temp condensers
CFB Esquimalt Esquimalt Pool	DHW & Pool Pool and DHW	Esquimalt Arena CFB Esquimalt	Ice rink condenser Ice rink condenser
Juan de Fuca Recreation Centre Priory Hospital	Pool, space and DHW Pool and DHW	Juan de Fuca Arena	Ice rink condenser
Crystal Pool	Pool, space and DHW	Save-on-Foods Arena Victoria Curling Club City Hall / McPh. Police Stn Agropur - Island Farms Dairy Office Buildings Telus and other switching stations	Ice rink condenser Ice rink condenser Space cooling Low & med. temp condensers Space cooling Data centre cooling
Legislative Precinct Royal BC Museum Empress Hotel Pacific Grande Hotel	DHW Desiccant de-humid, & DHW DHW Pool and DHW	Douglas Annex Bldg Royal BC Museum Parliament Buildings	Space cooling Dehumidification/space cooling New HVAC system
Royal Jubilee Hospital Oak Bay Recreation Centre Oak Bay Lodge Aberdeen Hospital	Space heat & DHW Pool, space and DHW DHW DHW	Royal Jubilee Hospital Safeway Oak Bay Arena	Space & process cooling Low & med. temp condensers Ice Rink
UVic	DHW	Racquet Club Arena	Ice rink condenser
AS APPLICABLE: Offices Condo/Apt Hotels Restaurants	DHW Pre-heat DHW Pre-heat, pools DHW Pre-heat, pools DHW Pre-heat	Supermarkets Restaurants	Low & med. temp condensers Low & med. temp condensers

Prepared by Bob Landell, ASCT, LEED® AP of Avalon Mechanical Consultants Ltd.

Water Reuse

Table 7 provides examples of Capital Region sites where there are opportunities for both water reuse and energy recovery.

Table 7: Potential Sites for Water and Waste Recovery in the Capital Region

Location	Water Reuse Opportunity	Energy Opportunity
<p>Garnet Street Pump Station</p> <p>Located 1 block south of the intersection of Shelbourne/McKenzie and immediately beside Bowker Creek.</p> <p>Some land is available, and the deep lift station could deal with a treatment plant.</p>	<p>Excess treated water could augment Bowker Creek</p>	<p>Heat could be provided to local shopping centres, seniors' homes and apartment buildings in the vicinity. Access is very good.</p>
<p>Haro Woods</p> <p>Located at the junction of the sewer lines from the Ash Road station, UVic line, and the Garnet line. All of these flow through the line that leads to the CRD lift station at Gyro Park.</p>	<p>Water could go to UVic, the Queen Alexandra Hospital, and the George Pearkes rehab centre.</p>	<p>Heat could go to UVic, the Queen Alexandra Hospital, and the George Pearkes rehab centre.</p>
<p>Rock Bay</p> <p>This area is under reclamation and redevelopment.</p>	<p>In planning the redevelopment of this area, opportunities for water reuse should be considered.</p>	<p>Heat can be directed to commercial and residential developments in the vicinity.</p>
<p>Marigold Pump Station</p> <p>A treatment station could be installed, and the force main could be used to send water to the Tillicum area where heat could be extracted.</p>	<p>Water can be reused or used to augment Colquitz Creek, reducing flows to the Gorge Siphon and to the Macaulay station.</p>	<p>Tillicum Mall</p>
<p>Oak Bay Marina</p> <p>A park near the Oak Bay Marina could be the location for a lift station.</p>	<p>There are many aging apartment buildings in this area that could be retrofitted, as they are renovated in the coming years, to use reclaimed water for toilet flushing.</p>	<p>Heat could be used for Glen Lyon Norfolk School and nearby multi-family developments.</p>

Location	Water Reuse Opportunity	Energy Opportunity
<p>Goldstream/Veterans' Memorial Parkway</p>	<p>Stream augmentation of Colwood Creek, as well as irrigation of Royal Colwood Golf Course, eliminating the need for water extraction from the creek.</p>	<p>Heat could go to the Westbrook Mall and other commercial and residential developments in the area.</p>
<p>Legislature The nearby Fort Street sewer line and other major lines could supply a small underground local treatment plant (see Figure 13).</p>	<p>Water could be used for landscaping purposes.</p>	<p>The Legislative Heating Precinct is a small district heating system currently fuelled by natural gas. Plans are underway to update this system as well as the heating systems in the Legislature. Treated effluent could be piped to the Precinct where heat pumps could extract heat energy to replace natural gas.</p>
<p>Victoria General Hospital</p>	<p>Water could be used for landscaping purposes.</p>	<p>Heat and cold could be used to supply the hospital, nearby school and residential developments.</p>
<p>View Royal Casino Located on the Old Island Highway, near Millstream Creek. The casino is looking at expansion.</p>	<p>Water could be used to augment Millstream Creek.</p>	<p>Heat and cold could be used for the casino, and nearby industrial developments on Wilfert Road.</p>
<p>Trent Street Pump Station Located near St Patrick's School, and ties into the North East Trunk-Bowker. Land nearby at St. Patrick's is owned by Saanich (Trent Street right-of-way)</p>	<p>During the summer months, reclaimed water could be used to augment stream flows in Bowker Creek.</p>	<p>Heat and cold could go to The Royal Jubilee Hospital, Oak Bay Recreation Centre, Eric Martin, St. Patrick's School, Fort and Foul Bay commercial district and apartments in this area.</p>
<p>Royal Bay, Colwood 600+ acre gravel pit along Latoria and Metchosin Roads being redeveloped to accommodate 2,500 homes</p>	<p>Latoria Creek has been severely ditched throughout most of its length, has extremely low flows throughout the summer months, and would benefit from stream flow augmentation for at least half the year. Also potential for discharge of reclaimed water to ground.</p>	<p>Dual plumbing in the homes would be relatively simple, given that it is new construction. District heating could also be incorporated.</p>

Water and Energy Recovery Cell Concept Diagram for James Bay

Water and Energy Recovery Cell (WERC)
The WERC (local treatment and resource recovery plant) will only be required to handle flows from part of Victoria (e.g. James Bay). If modern technology is used, the WERC could be small enough to be incorporated into an existing government-owned building near the Legislature. The plant would be designed to produce highly-treated water, which would meet regulatory standards for "unlimited human contact", allowing irrigation for example.

Organic Solid Waste
Because space is limited in the downtown area, biosolids from the wastewater treatment facility would need to be processed elsewhere. If curbside collection of organic kitchen waste begins in Victoria (pilot projects are underway in Oak Bay and View Royal), then the organic waste and the biosolids together could be converted to greenhouse gas-neutral biofuels and nutrients in a waste-to-energy facility.

Energy for heating, hot water, and cooling
Highly treated water could be pumped through water pipes to nearby buildings. There, heat pumps could extract enough energy to displace most of the natural gas currently burned for space heating in the winter, and for domestic hot water year round. After heat has been removed by the heat pumps, the water is cold enough to be used for air conditioning in the summer.

Potential clients in the area of the Legislature for heating and cooling from treated sewage include: the Legislature (Legislative Heating Precinct), BC Museum, Provincial government buildings, the Fairmont Empress and other hotels in the area, James Bay Community School, and the planned Belleville Development.
Although heat pumps consume electricity, the net greenhouse gas reductions achieved by replacing natural gas with heat recovered from sewage are significant.

Water for Reuse
Once the highly treated water has passed through the heat pumps, it could either be used for irrigation or discharged through a water feature similar to the one at Dockside Green. Potential clients in the area of the Legislature for reclaimed irrigation water include: the Legislature grounds, Beacon Hill Park, and St. Ann's Academy.
By replacing drinking water with reclaimed water for irrigation, we conserve our drinking water supplies for future growth, and help postpone the need for exploring watersheds for new sources of water.

Fertilizer
Nutrients can be recovered through the wastewater treatment process, for example using the Oterra process which recovers Crystal Green™ fertilizer. This inorganic fertilizer does not contain sludge (Dissolved), but consists of phosphorous, magnesium, and nitrogen. Recovering nutrients from waste reduces the pollution and greenhouse gas emissions caused by the manufacture of artificial fertilizers. Potential clients for reclaimed fertilizer include the Legislature grounds, Beacon Hill Park, and St. Ann's Academy.

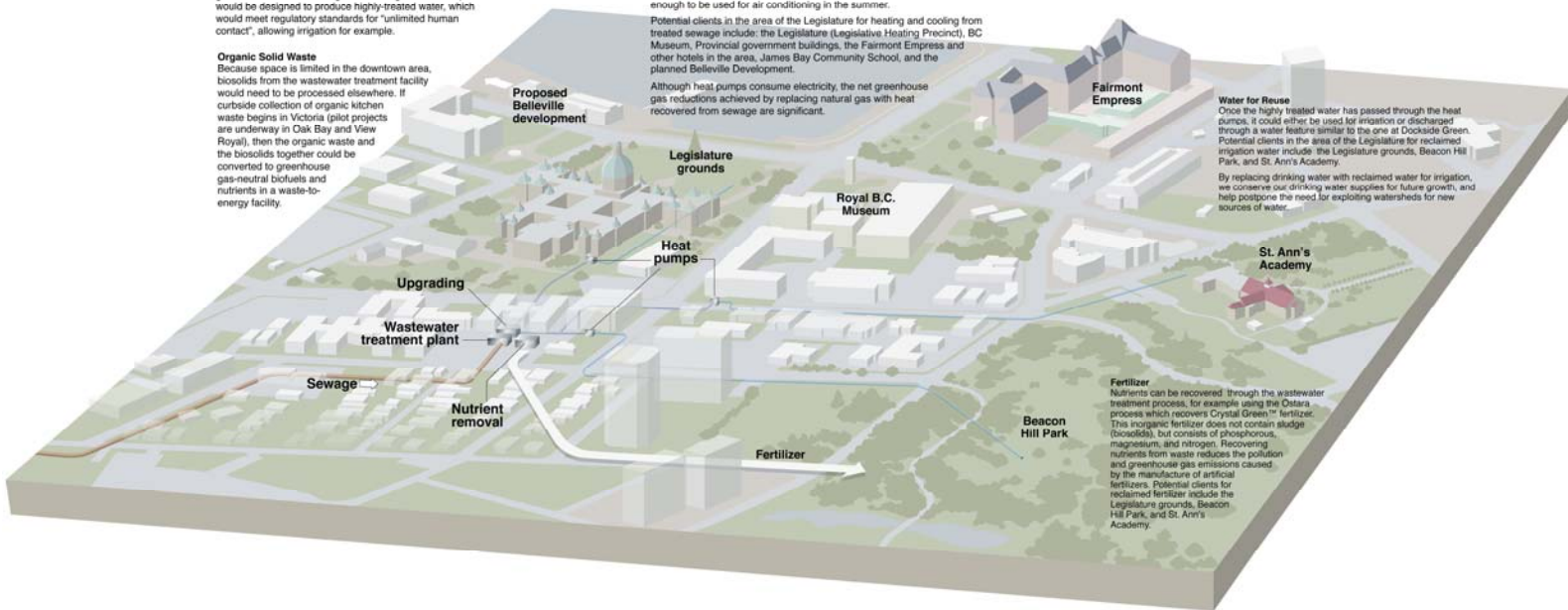

Figure 13. Water and Energy Recovery Cell (WERC) concept diagram for James Bay and Legislature Precinct

Capital Region Business Case Summary

As previously noted, the overall financial business case has been adapted to address environmental aspects. Although the province has announced the application of carbon taxes in its 2008 Budget, these taxes have not been incorporated into the business case. The Study Team has undertaken a preliminary assessment of the probable impact and concluded it will likely improve IRM's financial performance, but for expediency of time and budget, the model has not been revised to adapt to carbon tax. This would sensibly be undertaken in future modelling.

The overall financial position is summarised in Table 8. This notes several "scenarios" in which the main identified variables were evaluated with optimistic, pessimistic and 'balanced' views to evaluate the impact on the model. While this falls short of more sophisticated scenario analysis (using Monte Carlo or other simulations), it provides a simplified gauge of IRM's financial feasibility and viability.

The model was reviewed by, and input received from, knowledgeable analysts with financial, economic, business, accounting and valuation backgrounds. These were located both in BC and internationally. As an "order of magnitude" assessment it is considered by the team to reasonably represent the probable

financial picture for an implementation in the Capital Region, with the level of detail exceeding many initial Options Analysis assessments.

Table 8: Financial Summary, Capital Region IRM

	Chosen Values	Optimistic Values	Pessimistic Values
Annual Revenues	\$114,000,000	\$436,000,000	\$60,000,000
Annual Costs	-\$53,000,000	-\$50,000,000	-\$54,000,000
Net annual revenues	\$61,000,000	\$386,000,000	\$5,000,000
Projection to end (yr)	2065	2065	2065
Total NPV, IRM, stabilised	\$505,000,000	\$6,334,000,000	-\$244,000,000
Total Value (cost), stabilised, undiscounted	\$3,053,000,000	\$18,514,000,000	\$45,000,000
Capital Cost (Current Dollars)	-\$671,000,000	-\$600,000,000	-\$748,000,000
Capital cost (Inflated)	-\$870,000,000	-\$594,000,000	-\$976,000,000
Annual reduction in GHG emissions below 1990 in CRD (tonnes/yr)	378,000	404,400	367,500
Annual reduction in GHG emissions below 1990 in CRD (%)	23%	25%	23%
Annual electricity saved (\$)	\$6,000,000	\$12,000,000	\$6,000,000
Annual electricity saved and produced (GWhr/year)	116	129	124
Annual fossil fuel displaced - vehicle fuel (l/yr)	28,405,000	30,590,000	26,220,000

Note that the increased value of "Annual electricity saved and produced" under the Pessimistic scenario is caused by the assumption that annual water flows are higher under this scenario.

Figure 14: Capital Region Financial Summary Graphs illustrates the main aspects of the 'chosen' scenario to more graphically illustrate the conclusions and differences from selected financial conclusions. The detailed analysis is included in Table 16: Preliminary Scenario Analysis, Capital Region on page 145.

Figure 14: Capital Region Financial Summary Graphs



Capital Costs

Table 8 shows that under all scenarios, the capital cost of implementing IRM, adjusted for current inflation in construction costs, is likely to be less than predicted for a more traditional approach. The reader is cautioned that several factors make comparison difficult: IRM includes resource recovery cost and partially addresses upstream municipal infrastructure costs, and; CRD analysis is known to include other costs not detailed in published information, including financial, discounting and other aspects which may differ from those used to assess IRM.

Note that the capital cost estimates among the three scenarios do not vary widely. This is because two effects tend to cancel each other out when the more pessimistic values are used in the IRM model. If one is pessimistic about the amount of energy that could be sold, then the model rightly estimates that less infrastructure will be required to produce the smaller revenues. The 'balanced' financial assessment suggests a capital cost at the point of construction in the order of \$870M, which includes construction of resource recovery plants. Other assumptions include contingency and allowances for cost overrun, given the preliminary and conceptual nature of the current study.

While the cost of implementing IRM is projected to be less than a more traditional approach, the IRM model also includes expenditures required to maximise revenues. The costs thus have to be viewed in the context of the overall business case and potential benefits of IRM.

Given recent sensitivities to construction cost escalation, care was taken with estimating the capital costs. Costs for wastewater treatment were developed as follows:

- An estimate was developed by a professional engineer with an extensive background in the design of small wastewater treatment plants.
- Information was provided by the BC Ministry of Community Services concerning actual funding for plants of similar size in BC communities.
- A supplier was contacted to provide a preliminary cost estimate for supplying much of the plant and equipment.
- Lastly a 'real world' test of comparing the cost to known traditional smaller systems was used.

These provided a range of cost estimates and the cost adopted was above the median, and based on the cost estimate developed by the professional engineer (being the most detailed and accurately adjusted). Inflation and contingencies were included. Please see *Costs and Revenues* on page 138 for further detail.

The cost of land is not included in the IRM model, since it is assumed that the treatment plants will be located on existing pumping stations, existing rights of way, or incorporated into existing buildings. If the treatment plants have to be buried, this may add to construction costs as noted by some of the peer reviews. Some allowance was included in the model but as site-specific ground conditions are not yet known, it is not possible to be certain whether burying would produce a cost saving or increase. A contingency was allowed for this.

Benefits

The key benefits of the IRM model, shown in Table 8, are the potential to offset capital and operating costs with revenues. The 'balanced' model suggests that after adjustment for net annual revenues in the order of \$61M per annum (including net of 30-year financing), there is a net present value in the order of \$505M, *i.e.* net present value of gross revenues in the order of \$1.4B. The proportions of projected revenue sources vary depending on model variables, but illustrative proportions based on the chosen model are shown in Figure 15.

Less conservative scenarios show that IRM has the potential to yield greater revenues without significant increases in capital cost. The most conservative analysis run, based on inputs provided to us by advisors on CRD's Technical Advisory Committee, indicated that the IRM model would be unlikely to be significantly unprofitable, if at all. In short, the worst case suggested (including halving the projection period, trebling discount rates, using the lowest values on energy, doubling the marketing/sales period and so on) failed to make the model unviable to the point that it could not be considered a viable alternative to traditional systems.

In non-financial terms, the IRM model shows that converting sewage sludge and wet organic waste from the community into methane is profitable. Approximately 980,000 GJ/year of methane could be produced from sewage sludge and wet organic solid waste in the Capital Region. This would be enough fuel to run approximately 18,000 cars (9% of the cars in the Region). Since the "price" of the feedstock (waste) is stable, and the supply chain, quantity and quality considered reliable, the price of the resulting methane need not be directly related to the price of fossil methane.

One of the more compelling aspects of the business case is that IRM is more consistent with adopted government policies, strategies and direction at all levels (federal, provincial, regional and municipal), than traditional sewage treatment. See *Appendix C: Government Policies and Commitments* on page 76. Arguably the most important non-financial potential benefit is in terms of GHG reduction. Given the province's commitments on GHG reduction, the model suggests that if targets for fossil fuel and heating replacement can be achieved IRM appears to be a potentially significant contributor to achieving provincial GHG targets and thus, municipal targets (*i.e.* contributing to the BC Climate Action Charter

Figure 15: The proportion of revenue from each source on a "total cash" approach, which takes into account the capital, financing, operating and maintenance costs of infrastructure required to produce each revenue stream.

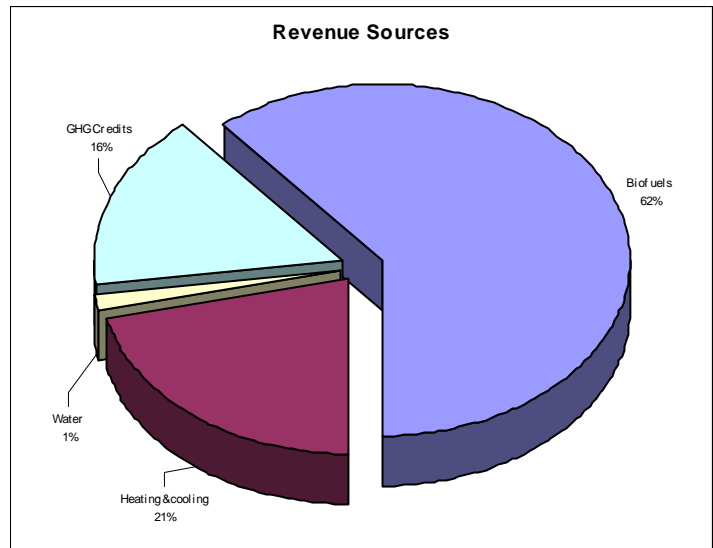

and the *Greenhouse Gas Reduction Targets Act*). It must be stressed that in order for these to be achieved, diligence in optimally implementing the model will be required.

Table 9: Annual GHG Emissions Projections, Capital Region

Item	Amount
Total reduction in GHG emissions	367,000 tonnes/year
CRD GHG emissions in 1990	1,617,000 tonnes/year
CRD GHG emissions in 1995	1,763,000 tonnes/year
CRD GHG emissions in 2004	1,532,000 tonnes/year
Reduction below 2004 emissions	23%
Reduction below 1990 emissions	22.7%

Table 9 notes that Capital Region emissions have changed, upwards from 1990 to 1995, but downwards in 2004.³¹ The reduction is credited to Hartland Landfill gas recovery. As part of the verification of the value of greenhouse gas credits which would be produced under IRM, actual reductions in greenhouse gas emissions and landfill gas capture rates would need to be verified by independent third parties, using internationally accepted protocols such as ISO 14064, ISO 14065, and guidelines from the Intergovernmental Panel on Climate Change and the World Resources Institute. There is no question that greenhouse gas reductions can be achieved: the only question is the extent of the reductions.

The IRM model shows that converting dry organic waste from the community into syngas to produce heat and electricity is profitable. Dry organic waste could yield approximately 116 GWh/year of electricity, and 390,000 GJ/year of heat energy.

The Study Team makes the following main observations:

- Markets and revenues. Markets for each revenue stream have to be secured and the values confirmed. For example the model assumes it will take appreciable time to secure the revenues and allowances were made for this, including: pricing marketable energy at 15% below wholesale value to attract and retain customers; approaching and securing preliminary commitments from key customers interested in implementing IRM; and ignoring the probable saving when owners replace plants as part of normal maintenance cycles. Work on these items will be necessary if the model is to be implemented optimally.
- Energy and fuels. The main revenues relate to energy and fuels, obtained either from heat or cold, or from fossil fuel substitution. Given the long life cycles of sewage infrastructure and consequent long cash flow projection, we researched energy price projections but found no reliable expert projections within the time and budget available, likely caused by the complexity

³¹ The source for the "CRD GHG emission" figures for 1995 and 2004 is: McEwen, B. and Hrebenyk, B. 2004. Greenhouse Gas and Energy Use Inventory for the Capital Region. p. 120. Since published data for 1990 GHG emission levels in the Capital Region are not available, a ratio based on the change in population from 1990 (301,128) to 1995 (328,337) was applied to the 1995 figure.

of this subject. The model is mostly reliant on displacing natural gas with biogas, which has comparatively low price inflation. Conservative estimates were adopted after consultation with BC Hydro and through them, other authorities. These may be exceeded, but based on current information, projections have not been relied on. More comment is provided on page 134.

- Savings. Savings compared to the current status quo and proposed treatment solutions have not been included in the analysis, as they represent the position of specific stakeholders. Thus, cost savings from replacing Hartland Landfill, avoidance of real estate acquisition and so on, have not been assessed. While they would likely favour IRM in most instances, this cannot be guaranteed.
- Reversionary value and asset maintenance. Common practice in recent years varies regarding sinking fund provision, but often omits it due to taxation on investment funds, which in effect acts as a detractor to developing and maintaining quality assets, *i.e.* arguably, an anti-sustainable policy. The model provides a nominal allowance for maintenance and this should be reviewed when greater detail and budgets are known. The model does not take account of reversionary value in assets at the end of their useful life, or capital replacement, which we believe mirrors analysis of traditional approaches. This should be reviewed as appropriate maintenance and allowance for sinking funds would better reflect sustainable investment.
- Real values of benefits over time. Both discounted and undiscounted analyses are shown. Both methods of analysis suggest it should be possible to attract businesses to operate IRM, or to yield a revenue stream to government. The difference between discounted and undiscounted value reflects the longer cash flow horizon with this type of infrastructure, and impact of discounting using current common financial practices. It indicates a reasonable likelihood of attracting suppliers, potentially without the need for taxpayer support or more probably, with capped cost to the taxpayer at today's values (which the model assumes). Work will nevertheless be needed to refine the analysis, should IRM be implemented.

The key non-financial benefits are reduction in reliance on fossil fuels, reduction in taxpayer burden compared to more costly alternatives, the improved flexibility to adapt to changes in population and circumstances, and the ecological benefits in terms of water demand offsets, groundwater recharge and carbon sequestration.

- Discount rate. Discount rates are usually one of the most sensitive aspects of a financial analysis. In scenario tests, the IRM model proved less sensitive to this assumption than had been expected. Nevertheless, the differences between the discounted net present value (NPV) and the undiscounted 'cash basis' illustrates that traditional DCF analyses tend to mask long term benefits. For example even with a conservative discount rate, \$100 at the end of the projected cash flow was being discounted to approximately \$6. This goes some way to understanding how traditional financial methods 'devalue' our future, and left unchecked, can lead to short-term bias. Both discounted and undiscounted indicators suggest IRM is a viable model, the difference being the magnitude of value.

See *Appendix G: Valuation Methodology* and *Appendix H: Business Case* starting on page 119 for further background.

Risks

It was agreed that a more sophisticated risk analysis would not be possible within the limits of time and budget. Basic comment is provided below. A more detailed analysis is included in *Business Case Risk Analysis* starting on page 146.

The main concern relates to cost projection, given the preliminary nature of this analysis. Cost figures for resource recovery infrastructure in this report are estimates, based on the implemented costs of comparable resource recovery facilities in Canada. The scoping level cost estimate for the decentralised treatment plants is based on a design developed by David Jackson, PEng of Worley Parsons Komex. A number of the peer reviewers sought detail on the cost estimates for the small, distributed treatment plants. The Study Team undertook this estimation process within (or arguably exceeding) the level of certainty normally applied in a proof of concept study, and recognise that this will need refinement when applied to real projects.

Completed projects with similar capacities to those required in the model were found for each type of infrastructure (e.g. biogas digesters, gasifiers, and so on). The capital costs of these projects were calculated based on the reported cost and capacity of each project (e.g. \$/tonne/year of digester capacity). This is a very approximate approach, which gives an estimate only. Detailed design work for a given community will be needed to determine the cost of each facility. The final costs will be affected by several trends, including upward pressures on costs because of escalations in construction costs, and downward pressures on equipment costs because of advances in technology.

The second major concern relates to revenue projections. As noted previously, conservative estimates were used, with appropriate contingencies. Work to secure these in the Capital Region will be important.

The third significant issue relates to industry and the professions. Currently, there may be limited experience in planning, designing, and implementing full IRM, since integrated resource management has not been called for by local governments; this represents risk in implementing it optimally and successfully. The main way to mitigate this is to establish some form of collegiate model to support and inform professional and expert resources, and to support municipalities. A project office would help speed and effect this change and, as a by-product, would invest in BC expertise. A traditional linear scope-design-cost-bid-implement method is unlikely to optimise the model and achieve the anticipated benefits.

A fourth area of risk is in failing to understand that the model used for IRM relies on an integrated valuation approach. Traditionally, business management and valuation has a less important role, however if IRM is to be successfully implemented in the Capital Region, a more cohesive approach is needed, with the business case helping determine the direction. The business case must include environmental indicators and aspects if CRD or any other municipality is to optimise the benefits.

A number of the reviewers pointed out that multiple distributed waste treatment plants would constitute a risk factor in gaining public support, for finding suitable locations in some cases and in servicing costs. The Study Team recognises that this aspect of the IRM model is risky but (a) point to the potential

benefits of well-sited plants to provide local district heating; (b) the potential source of water that can offset the need to use precious potable water in water constrained regions of the province; and, (c) note that in a preliminary instance in Central Saanich, the concept received overwhelming public support (5:1 written support, including from objectors), and staff support for IRM. There is thus some preliminary comfort that the risk of community rejection of the concept may be solvable through public information.

CRD Business Case Conclusions

We draw the following main observations and conclusions:

- Notwithstanding the preliminary and conceptual nature of the IRM model³², all three main scenarios indicate sufficient potential advantages to recommend further assessment, including more detailed assessment for application in the Capital Region;
- Because many IRM components are “off-the-shelf” and can be bid competitively, it is anticipated to be less expensive than the traditional “economies of scale” approach *i.e.* less expensive to procure and construct. The margin of benefit is sufficient to conclude that even if no revenues are obtained, IRM is likely to be preferred over alternatives;
- Revenues are largely dependent on the sales of heating, cooling, green electricity, and biogas. Conservative assumptions have been made in most scenarios to address this. Discussions with possible major energy buyers have been held and it is estimated approximately 50% of the revenues are immediately saleable, *i.e.* exceeding the assumptions made in all scenarios. This is based on discussions with several large organisations who are signatories to a commitment to sustainable principles, compatible with IRM; and
- Application of the full IRM model could achieve a potential 23% reduction in GHGs, below 1990 estimated levels in the Capital Region. This level of achievement would require a concerted effort from both the provincial and local levels of government.

The main reasons the Study Team concluded that IRM is more effective than traditional solutions to wastewater in the Capital Region, include:

- The standard approach to sewage management can be summarised as a scope-design-cost-bid-implement linear process, addressing wastewater within the wastewater department. IRM is not constrained by departmental operating structures and considers a larger array of issues. The model shows this synergy to be effective and viable because it considers the wider impact of revenues, not all of which are identified within an analysis restricted to wastewater department operation;
- The traditional approach to sewage is to manage flows. The IRM approach is to maximise resource values and include ecological function in an integrated business case. As a result, IRM determined the optimal method of moving the treatment system upstream within the collection

³² The IRM model developed for this analysis lacks the detail of the CRD model, which is adapted to specific circumstances and sites. The IRM model is a preliminary model and reliance cannot yet be placed in the projections as being final numbers. Nevertheless they provide a comparable "order of magnitude" indication of IRM relative to a more traditional approach.

system, which has benefits in reduced flows and thus, energy costs. Combined with the resource utilisation underlying IRM, this improves viability;

- Traditional thinking is that larger plants have economies and efficiencies of scale. IRM benefits from being smaller, thus enabling competitive bidding with off-the-shelf systems. Smaller systems are more flexible, raising performance and innovation, benefiting technology and thus, efficiency and viability. This concept needs to be proven through demonstration projects;
- Traditional systems are dependent on a large piped infrastructure. IRM is less dependent on expanded trunk lines and twinned outfalls since reclaimed water is returned to the neighbourhoods which produced it.

The Business Case for IRM in British Columbia

Potential Benefits of an IRM Approach

During the analysis of the application of IRM to the Capital Region case example, it became clear to the Study Team that there are many benefits associated with applying the distributed treatment approach to other municipalities in the province even where centralised treatment plants are operating.

- **Just-in-time treatment.** Small plants can be implemented in step with growing populations and large-scale developments or redevelopments, where the growth occurs, as opposed to a traditional method which constrains services and growth. This defers expenditure until it is necessary, prolonging the life of existing wastewater infrastructure and allowing the implementation of the most up-to-date technology for new treatment capacity.
- **Speed of implementation.** Instances were identified where IRM localised treatment plants had been temporarily implemented, for example in a California community. One visited by Study Team members and confirmed independently was supplied within a week as an emergency replacement of an existing (failed) traditional treatment facility. The plant capacity was not optimal but demonstrated both the smaller size of "off-the-shelf" equipment and the ability to implement quickly. It also demonstrated the benefit in terms of redundancy and risk issues.
- **Competition for cost.** Small plants can be built under tender by competing firms, resulting in lower cost. Economies of mass production will also apply to the large number of small modular components of small plants (tanks, pumps, etc.).
- **Construction time and risk.** The risk of time, and hence cost, overruns during construction is significantly smaller for small \$10 million plants occupying 300 m² (approximately 3,300 square feet) than for a single plant occupying several hectares and costing several hundred million dollars. In addition, the lessons learned in building the first small plants can be applied beneficially to the remaining installations.
- **Competition among technologies.** Different firms can offer different technologies, and over time, the technologies which perform best can replace the weakest, resulting in overall improvements in treatment cost and benefits.
- **Resistance to technological obsolescence.** Wastewater treatment and water purification technologies are progressing rapidly, driven by the recognition by municipalities and industry that water and energy are increasingly valuable. For example, microbial fuel cells are currently

under development at Washington University in St. Louis which produce electricity directly as they treat wastewater³³. It will be simpler to take advantage of these advances as new plants are required, and as the equipment in smaller (decentralised) plants wears out, than it would be to replace equipment in large centralised plants.

- **Tailored solutions, input side.** Individual treatment plants can be tailored to local raw sewage (influent) conditions, making treatment more efficient. Plants receiving flows with high degrees of inflow and infiltration of rainwater for example, can be designed for these conditions.
- **Tailored solutions, output side.** Individual plants can also be tailored to meet the needs of local energy and water reuse, making resource recovery more efficient. This idea was expressed by a member of the Technical Advisory Committee as "tailoring the risks and rewards as they emerge over time".³⁴
- **Resilience.** Large plants are vulnerable to failures of critical pieces of equipment. In response to this vulnerability, large plants tend to require a significant amount of redundancy, which increases cost. Distributed plants that are interconnected and can refer loads to each other, are inherently less vulnerable to failures. If an individual plant fails, then its load can be piped to nearby treatment plants.
- **Lower cost of spares.** Large plants must maintain spares for critical items of equipment. Since these items of equipment are large by nature, the cost of the spare parts inventory is high. With a large number of small plants, a smaller inventory of smaller parts can be maintained, reducing the inventory cost. Components for small treatment plants are also more readily available: it is easier (and cheaper) to buy a 10 horsepower motor than a 1,000 horsepower motor, for example.
- **Lower capital cost.** Because the IRM treatment plants are designed to allow highly-treated water to be re-used locally, the IRM approach has the potential to reduce the need for new and expanded outfalls and conveyancing in the form of trunk line expansions and other piping.
- **Lower energy consumption for pumping.** The Study Team has documented potential energy savings associated with the use of distributed plants.
- **Lower sewer pipe O&M.** When highly treated water is delivered for local reuse, some sewer lines which would have carried the water to a central treatment plant can be abandoned.
- **All neighbours treated equally.** The social implications of smaller distributed water treatment plants have not been assessed. It is possible that the NIMBY syndrome will apply to such plants making their location subject to a public hearing process; however, others neighbourhoods may see a local plant as desirable, especially if it reduced household energy costs.
- **Opportunities for innovation.** Wastewater treatment and water purification technologies are progressing rapidly and will benefit from innovation that will reduce costs and improve efficiencies.

³³ He, Z., Minteer, S.D. and Angenent, L.T. (2005) Electricity generation from artificial wastewater using an upflow microbial fuel cell. *Environmental Science and Technology*. Vol 39, No 14, pp 5262-5267

³⁴ Peter Adams, IRM Study Technical Advisory Committee, September 20, 2007

- **Better use of land.** Small distributed plants can be located in and above existing pumping stations, in the basements of new or existing commercial buildings, or on marginal land, including contaminated sites³⁵. This will result in lower overall cost of land acquisition for treatment, lower environmental impacts of land use, and will make waterfront property available for other uses.
- **Cost savings and revenue potential for building owners:** Lower capital, operating, and maintenance costs as boilers, chimneys, and air conditioning equipment are replaced with simple heat exchangers. (In coastal communities, rooftop condensing units in air conditioning and refrigeration systems are typically replaced every 15 years as a result of exposure to the salt air and elements).³⁶ Sewage-source heat pumps do not incur the cost of drilling and installing pipes required by conventional ground-source heat pumps, which account for approximately half of the capital cost of these conventional installations.
- **Jobs:** Producing heating and cooling from local waste streams will create local, sustainable employment. For example in Gothenburg, Sweden (population 500,000) Göteborg Energi employs approximately 1,000 people who manage and maintain waste-to-energy facilities, including district heating and cooling networks.³⁷
- **Ecosystem resilience:** Reuse of treated wastewater can contribute to the resilience of aquatic ecosystems across the province to accommodate increased drought and flood events due to climate change. Many urban watersheds have low water tables due to rapid runoff as a result of impervious surfaces. IRM allows dispersal of reclaimed water over the landscape, taking maximum advantage of natural assimilative capacity, recharging groundwater and providing additional flows in summer droughts to support fish populations.

Potential Challenges of an IRM Approach

Governance

Application of the IRM model represents a new approach to managing waste resources and will be a challenge for the traditional organisation of provincial and local government to implement. It will cause disruption to the normal way of doing business and thus be seen as a threat initially. However with the announcement of the Province's climate change agenda it appears to be the right time to institute the kind of changes needed in governance to capitalise on the benefits outlined above. Other challenges to implementation of the IRM model include:

- **Wet weather flows:** In the Capital Region wet weather flows during November to February can increase hydraulic load by up to four times above Average Dry Weather Flows. The IRM model

³⁵ Cocivera, Maginnis. 2006. Re-inventing the Wheel: Designing New Infrastructure for the Energy Harvesting Age

³⁶ Bob Landell, LEED AP, Principal, Avalon Mechanical Consultants Ltd., Victoria.

³⁷ Personal communication between Stephen Salter PEng and Peter Maksinen, Göteborg Energi on October 5, 2007

has attempted to manage these flows, but, as suggested by the peer review group, more analysis will be required to ensure they can be dealt with efficiently in a given municipality.

- **Site selection and acquisition:** It will require more administrative effort to identify, acquire and build a system of distributed small treatment plants rather than a few central plants.
- **NIMBYism:** In spite of efforts to blend decentralised treatment plants into their surroundings, community perception of traditional sewage treatment may cause a NIMBY (Not In My Back Yard) reaction. Mitigating this will be the fact that the smallest plants could be located with existing pumping stations or within new or existing buildings. Significant communication effort will be required to explain the environmental, economic, and social benefits of distributed water facilities compared with traditional sewage treatment plants. Centralised plants would also be subject to NIMBYism, but on a different scale.
- **Ownership:** Policy decisions will have to be made on “who owns and manages, who makes profit from” the system. This could be a public-private partnership, a municipal energy company, or a not-for-profit organisation.
- **Administration:** It will require more administrative effort to maintain and operate a system of distributed small treatment plants rather than a few central plants.
- **District heating and cooling:** Building owners will need to be convinced of the benefits of converting to heat pump energy. Regardless of which approach to district energy is taken, pipes will need to be installed between the decentralised treatment plants and the buildings which will be served by this form of energy.
- **Biogas plants and biogas use:** Biogas plants can cause odours, depending on the adequacy of design of material receiving equipment and air-scrubbing biofilters. Ideally a small number of local biogas plants would be sited to minimise the distance travelled by municipal collection trucks. If this is not possible, then biogas facilities would need to be located in areas which are less sensitive to odour, such as on landfill properties or in agricultural areas, or have adequate odour control facilities. Since over three thousand biogas plants are operating in Europe, there is sufficient experience to be satisfied that this could be handled properly. Sewage sludge contains metals and other contaminants, therefore its residues are not suitable for application to agricultural land. For this reason, cities in Sweden operate biogas digesters for clean organic food waste separately from those which process sewage sludge. If British Columbia communities adopt the same practice, then residues from the clean digesters could be returned to farmland as fertiliser, rather than added to the waste stream for gasification.

There is a cost to converting vehicles to methane, which could be offset by government incentives, as is the case in Europe. In Kristianstad Sweden for example (see Figure 16) the conversion cost is subsidised by the government, and owners of biogas cars are granted free parking.

Distribution facilities for methane as a vehicle fuel are limited in many British Columbia communities; the City of Victoria for example has only one location for methane filling. These facilities would need to be built either by the communities, by municipal energy companies, or by other energy proponents.

If the administrative barriers to using methane for transportation prove to be excessive, then this greenhouse gas-neutral fuel could be used to operate cogeneration equipment to produce electricity and heat. There would be an efficiency loss.

Raw biogas consists of methane, carbon dioxide, water vapour, and trace amounts of sulphur compounds such as sulphur dioxide and hydrogen sulphide. The IRM model includes infrastructure costs for biogas upgrading equipment which separates methane from raw biogas. Raw biogas and purified methane do represent hazards however, and these hazards will need to be defined and mitigated at the detailed design stage by means such as Hazardous Operability Studies, Failure Modes and Effects Analysis, and Monte Carlo simulations.

Figure 16: Biogas Plant in Kristianstad, Sweden



- **Gasification plants and cogeneration from synthesis gas:** Synthesis gas consists of a mixture of gases including hydrogen, methane, and carbon monoxide. The gas stream also includes tars which cause operating problems in reciprocating engines and gas turbines. GE Jenbacher is currently working on a class of engines which will tolerate tars better.
- **Source separation:** Efficient operation of waste-to-energy facilities will rely on either source separation of waste streams or mechanical separation at the treatment facilities. Source separation is the most efficient option, and European cities encourage it by charging more for un-separated waste.
- **Redundancy:** The preliminary design for the Water-to-Energy Recovery Plants (WERCs) has provided capacity for redundancy to accommodate high flows and equipment failure. The advantage of the IRM approach is its modular design that enables overflows to be routed to the next component in the system. More detail on redundancy planning and modelling will be required to ensure that a distributed network of WERCs can perform reliably under all flow conditions.
- **Building Code:** The current provincial building code discourages the IRM approach by requiring discharges to sewers, not linking organic solid waste with resource recovery and not supporting water reuse and groundwater discharge. Proposed changes to the Green Building Code need to provide an integrated approach as set out in the IRM model.

Statutory & Regulatory Requirements

- A key feature of IRM is the integration of liquid and solid waste planning. There will be implications associated with viewing these waste streams as resources with potential value. The amendments to the liquid and solid waste plans will need to consider how to maximise value from resource recovery and the governance of managing a resource that has value.
- In British Columbia, the regulatory framework that affects the use, distribution and discharge to the environment of non-potable water includes the *Drinking Water Protection Act* and Regulation, Municipal Sewage Regulation (MSR) and the BC Building Code.
- The MSR allows a range of possible uses for reclaimed water, but restricts the use of spray irrigation to mitigate possible health risks from air-borne contaminants. This policy may limit potential values of water reuse from tertiary level of treatment. If the regulations were oriented towards increasing reuse linked to the quality of water, greater recovery and reutilisation may be possible.
- The reclaimed water standard does not apply to subsurface ground discharges where Section 12 of the MSR applies or the Sewerage System Regulation applies.
- There are additional impacts from the BC Building Code, which governs non-potable water systems, essentially requiring that they be fully separated from potable water systems. This is likely spurred by health and safety requirements. Opportunities to double plumb buildings may be addressed through the ongoing development of the Green Building Code.
- It is possible that BC Utilities Commission regulations will govern the sales of energy and water from IRM facilities, and further work will be needed to learn whether or not the regulations will facilitate or hinder resource recovery.
- There should be an integrated review of environmental regulations in the *Water Act* for licensing reuse of non-potable water, and the *Environmental Protection Act* to encourage resource recovery for both solid and liquid wastes.
- The Canadian government is developing national standards for municipal wastewater treatment through the Canadian Council of Ministers of the Environment (CCME).³⁸ The standards and eventual regulations should be reviewed from the perspective of Integrated Resource Management to ensure they will encourage, rather than discourage, IRM.
- In general, wastewater discharge codes would need to be modernised to specifically address innovative methods of discharging high quality water such as direct or indirect discharge to surface or near surface drainage where natural dilution ratios are low or seasonally non-existent. Examples would include discharges to vegetated swales and berms, constructed exfiltration beds, evapo-transpiration cells and artificial springs in minor watercourses. These changes would require a different risk analysis approach than has to date been applied to sewage disposal.

³⁸ CCME. Canada-wide Strategy for the Management of Municipal Wastewater Effluent. 288 pages

Government Structures

- **Silos in government:** Municipal, regional, provincial, and federal regulations and administrative structures for potable water, wastewater, solid waste, energy, climate change, and community planning tend to be isolated from one another, so that proponents of an IRM approach face a number of "silos" when advancing their plans.
- **Silos in consulting:** When consultants are hired by local governments, they are often asked to solve a very narrowly defined problem. The quality of the solution to that problem may be high, but if solutions are not integrated, the result will be sub-optimisation. Successful sustainable developments on the other hand use integrated design teams of architects, engineers, ecologists, economists and others. While specialists working in isolation tend to solve problems by analysis, integrated teams solve problems by synthesis.
- **Template thinking:** If municipalities and regulators follow paths which appear to have worked in the past, they will miss the opportunity to solve the problems of the future.
- **Divergent views of risk:** Ecologists recognise physical risks to the environment, such as climate change. Engineers see technological risks that a system will fail to meet requirements. Administrators and politicians see risks from negative public opinion. If administrators and politicians are motivated to avoid risk, decisions may be taken which minimise administrative risk but which may increase environmental and social risks.
- **Brainstorming versus critical reviews:** Innovative projects include two distinct phases. In the initial brainstorming phase, creative and lateral thinking is encouraged in order to reveal solutions which are less accessible through linear thinking. In the subsequent, more detailed stages of planning, ideas from the brainstorming phase must be critically evaluated and sorted. If critical reviews of details are allowed to dominate the brainstorming phase, then the result will be sub-optimised decisions.
- **Lack of competition Among ideas:** Design competitions can uncover superior solutions to problems of infrastructure planning, but competition among design strategies at the earliest stages of municipal infrastructure planning may not be consistently used by municipalities.
- **Inadequate time:** Elected officials may not have adequate time to research the issues on which they must make decisions. As a result, they may not feel comfortable asking questions about the economic and technical aspects of proposals for major infrastructure. If they are presented with limited choices and have little opportunity to apply creative problem solving, then the outcome may be less than optimal.
- **Tax disincentives:** As individual municipalities or developments implement IRM by treating their own waste streams, new revenue/tax models will be required. If Canada intends to encourage sustainability, IRM proponents should be given financial incentives which will encourage IRM. When communities or new developments become self-sufficient concerning waste treatment, local governments may try to replace "lost revenues" with new taxes targeting these developments when fewer water, sewer, and garbage services are required. This acts as a disincentive to sustainability

- **Financial:** Most municipalities have developed a financial structure to address infrastructure costs for sewage and solid waste collection systems, but may rely on senior levels of government for funding. IRM can shift this balance and incur upfront costs for distributed treatment or resource recovery systems. The revenues from resource recovery will have to be factored into these financial frameworks and this will affect provincial and federal grant systems. Further investigation should cover a range of financing options and incentives to make IRM profitable for municipalities with mature waste management systems.
- **Cost sharing programs:** There is a variety of federal-provincial infrastructure cost sharing programs for water and waste systems. All these programs should be reviewed to ensure that they provide an incentive to apply the IRM approach across the province and not continue to support the traditional models of water and waste management.

Change Management

Should senior and local governments decide to proceed further with IRM, there will be a need to consider change management. IRM will involve significant changes to traditional decision-making models in both provincial and local levels of government and will require public acceptance. The last chapter in this report contains a number of questions and possible answers that could be used by governments to inform the public about IRM.

Public Change

Based on a CRD opinion survey³⁹, the key public concerns are ecology, odours and costs:

- **Ecology.** As noted in this executive summary and the body of the report, IRM has higher environmental compliance and benefits than traditional systems, including ecological reinvestment ("restoration economy" aspects);
- **Odour.** The technology required for neighbourhood waste treatment/ heat recovery plants means they will be located closer to neighbourhoods, which will concern the public. There will be a need to communicate that IRM has less risk of odour or leakage than with traditional systems;
- **Cost.** The cost and value impact is a concern to taxpayers. IRM is anticipated to have a lower net cost to the taxpayer as it recovers resource revenues. There will need to be effort to ensure these are obtained. If there is an available market for the recovered resources, the cost of retrofits should be small and may be funded through revenues. Impact on property values from localised treatment plants is not thought to be a financial issue, although it may be an emotive issue.

Considerable effort and funding will be needed to address public communications. Experience in other initiatives is that clear, concise and transparent communications will speed implementation and help mitigate misinformation.

³⁹ Ipsos Reid Public Affairs, November 2006. Capital Regional District Public Opinion Survey.

Government Role, Procurement & Management Change

Under all circumstances, government's role is to ensure that regulatory standards are met and the public interest is protected. In the most favourable circumstances with IRM, those components that are fully cost recoverable could be financed and operated by the private sector. At its highest level of deployment, IRM can thus be a regulatory and oversight model.

This will vary by instance and community however, and it is unlikely that viability can be achieved without government facilitation or involvement. Those components that require facilitation or public sector finance will require government involvement. The financing programs for solid and liquid waste management infrastructure need to be carefully reviewed to ensure that they encourage the IRM approach where applicable.

In addition, the IRM model provides opportunities for innovation in technology development, in planning process and municipal zoning bylaws. Both the Provincial and local levels of government will need to develop administrative processes that encourage innovation and the use of new intellectual property and develop procedures that are sensitive to removing barriers that constrain such innovative approaches.

The main area of change management is thus within government, amongst wastewater and business case professionals, and industry. People are used to a specific way of doing business. IRM requires integrated consideration of multiple aspects and this alone requires change management. It will be necessary to invest in informing bureaucrats, consultants and others of the impact of this shift. Work will be needed on this to gather and form best practices, to inform and educate, and to facilitate IRM being implemented. This strongly suggests it will make sense to establish a central resource that helps:

- The private sector work with government (to remove road blocks, facilitate bylaw and other changes etc.);
- Inform professions, government and industry, using a collegiate method. This would have minor involvement in IRM projects to help facilitate, but also to provide central knowledge and from knowledge of each project, allow dissemination of experience; and,
- Facilitate funding change by helping support the IRM business case, required for government, the private sector and funds.

Creation of a project office with contract staff and sufficient authority is the preferred option as this can be closed once its task has been completed and IRM has become mainstream. This will help address remaining risks and aspects not fully addressed by the preliminary nature of the current analysis.

We believe this change can be encouraged by illustrating the potential benefits and rewards resulting from a move to IRM, but the province may need to consider some form of mandate, especially if change is to be accelerated and help meet GHG reduction targets.

Conclusions

This study was commissioned to identify whether Integrated Resource Management (IRM) is applicable province-wide and to provide a preliminary understanding of how it may be applied to British Columbia's Capital Region. In addition, the study was designed to assess the potential contribution the IRM approach can make to achieve the province's climate change agenda and Green Cities Program. Given that the study is presented largely at a conceptual level of analysis, the Study Team reached the following conclusions:

- IRM has the potential to be a viable solution to water, solid and liquid waste management that should be less expensive, result in fewer environmental impacts, and provide greater flexibility than traditional approaches to waste management;
- The advent of a graduated carbon tax on fossil based fuels will add considerable value over time to the IRM model which can generate significant amounts of non-fossil-based energy sources;
- Nevertheless, further work is needed to evaluate IRM. There remain significant and more detailed analyses, as set out in this report and by the peer reviewers, that have to be undertaken before it can be adopted without reservation;
- All the technologies presented in this study are well-established, currently operational and in use in various jurisdictions, however we are not aware that they have previously been fully integrated in a single location, in a region-wide application;
- IRM has the potential to contribute to GHG reduction targets. In the Capital Region example, it could result in approximately up to 23% reduction from 1990 GHG levels if the IRM model can be fully deployed and there are markets for all non-fossil-based fuels generated. Provincially, this could translate to an appreciable reduction in GHGs from a single initiative that government controls. Achieving this will depend on how quickly and efficiently IRM can be implemented;
- IRM can contribute significantly to the Province achieving its goal of operating a carbon neutral government and public institutions by 2010 and 33% reduction by 2020. Should the province decide to implement it as a program, it could theoretically achieve nearly two thirds of the province's goals, achievable in the timescale set by the province and potentially, with little or no cost to the taxpayer. Few similar initiatives are currently known to the Study Team capable of achieving this level of benefit without appreciable taxpayer cost or societal change;
- IRM has the potential to significantly reduce the consumption of electrical energy required to move and treat water. It therefore has the potential to assist the province to achieve its Energy Plan through a combination of reduction in energy use and the creation of new energy sources;

- IRM has the potential to produce electricity and heat from carbon-neutral sources. Even after the additional electrical loads of heat pumps is taken into account, the IRM model predicts that if IRM is applied to a community, the effect would be a net production of electricity for sale into the grid;
- IRM can contribute to the Province's water strategy by recharging streams in the summer and fall to sustain environmental flows and conserving water in municipalities through reuse for non-potable requirements;
- IRM is fully consistent with the government's LiveSmart BC initiative outlined in the 2008 Throne Speech. This initiative supports 'carbon smart communities, that are energy smart, water smart, health smart and resources smart' These are all the same principles as IRM and the foundation to this proposal;
- IRM exceeds typical current environmental discharges from most waste treatment plants. Water treated to a tertiary level and discharged to wetlands can enhance localised carbon sequestration together with ecosystem reinvestment;
- IRM is a new way of thinking and will best be implemented by integrated governance systems. Education and information will be required to encourage traditional structures of government to shift from a sectoral approach to an integrated approach to decision making;
- The BC Transportation Plan identifies the need for bioenergy to fuel transit buses. The IRM model can provide a source of such fuels for this purpose;
- The Study Team has included in the report (see Table 3 on page xi) a road map for local governments to use for evaluating implementation of IRM. Generally IRM will be more attractive to communities which require immediate upgrades to infrastructure and that have rapidly developing areas such as the West Shore area of the Capital Regional District. It will be less attractive to communities with well-developed infrastructure and stable development;
- Recent direction from the BC Minister of Environment to the CRD to complete revisions to its liquid and solid waste management plans is entirely consistent with deployment of the IRM model;
- The Ministry of Environment, when reviewing the implications of IRM on its liquid and waste management plans, will have to consider the full implications of viewing waste resources as assets rather than liabilities in allocating management responsibilities for these resources between regional and municipal governments.

Recommendations

The Study Team offer the following recommendations.

1. The IRM model should be further refined through implementation of carefully selected pilot projects in BC communities in accordance with needs and opportunities to support the Province's climate change action plan. Provided ongoing monitoring and assessment of these pilots provide satisfactory results, a more broadly-based implementation approach should be undertaken. The IRM study was initially intended to be conceptual in its level and scope of analysis. However, the additional analysis conducted to-date and the responses of the peer reviewers provide a sufficient level of assurance to recommend early implementation of pilot projects.

2. The IRM model should be refined without delay, as without its early implementation, traditional projects will continue. Traditional plant commitments will result in increased GHGs, increased power consumption, reduced revenue potential, failure to achieve water and energy conservation and reduce the ability to optimise generation of power, heat, fertiliser and biofuels.

3. At least one sizeable community in the Province should apply the full array of IRM as a demonstration project to use the iterative business model to seek out maximum values, to assess all relevant costs, to engage the citizens in a real example of whole city change and to determine the potential for GHG reductions. Such a demonstration project would place the province in the forefront of the Green City agenda and provide the potential to twin the project with a similar-sized community in one of the US states and Canadian provinces under the Western Climate Initiative.

4. IRM requires an integrated team approach to implementation. The Province should establish a project office to implement IRM whose members are innovative thinkers from across government and the private sector and form a complete and balanced team with the expertise to address both the technical and governance aspects of IRM. This team should:

- Continue with more detailed modelling to refine the cost and revenue potential for IRM in the Capital Region, and elsewhere in the province, on a site-specific and integrated network basis;
- Assess in more detail the risk associated with the implementation of the IRM model and ways to reduce these risks through market incentives and associated government policies;
- Identify how and where the IRM model might be applied to achieve the target of public institutions, including post secondary institutions, becoming carbon neutral by 2010 and to support GHG reduction by 33% by 2020;

- Work with UBCM and the Ministry of Community Services to encourage local governments to apply the IRM approach to all new infrastructure expenditures. Specific circumstances for individual projects will determine the extent to which IRM can be deployed;
- The project office should identify at least six to eight municipalities and regional districts from various regions of the province that are in a position to apply components of IRM to liquid, solid waste and water supply system expansions and upgrades. Bring a prioritised order to Cabinet, with recommendations, within six months;
- Immediately develop a strategy to collect organic solid wastes in municipalities to take advantage of integrating solid and liquid waste management plans. Every day there is delay, a source of carbon neutral energy is being lost and more methane is emitted from landfills;
- Develop and require new business case metrics for evaluating projects. More on this is noted separately, below;
- The Province should require all liquid, solid waste and water supply infrastructure upgrades and expansions submitted for provincial funding to include IRM or at least meet new metrics for evaluating applications and help achieve the GHG targets;
- The review of waste management plans should consider the implications of waste streams having a value and how this value is allocated between municipal and regional governments and with sources of waste from the private sector;
- IRM is designed to be fully compliant with all current applicable environmental and health standards in BC; however, the Province should review all relevant legislation and regulations that apply to the implementation of the IRM model and remove unnecessary barriers. This review should involve an integrated evaluation of water licensing, waste management, health standards and municipal infrastructure financing programs. Bring this review back to Cabinet within twelve months;
- Integrate the following regional plans and planning processes as soon as possible:
 - Liquid Waste Management Plans
 - Solid Waste Management Plans
 - Regional Growth Strategies
 - Official Community Plans
 - Community Energy Plans
 - Water Servicing Plans
- Integrate government plans for a green building code with the IRM model, to ensure they are mutually compatible and provide clearer and immediate direction to developers to apply the IRM model to new large-scale developments across the province;

- Some municipalities require unnecessary duplication of infrastructure, or levy charges for avoiding traditional infrastructure. This acts as a disincentive to environmental responsibility and IRM. Ensure that the IRM model is not harmed by current development cost charges, levies, taxes and debt financing policies in municipalities. Ensure that municipal, regional and provincial policies act as an incentive to encourage IRM applications, and not as a barrier;
- Use the project office to monitor and ensure adaptive learning and development of IRM during implementation to initial projects, such that the model can be continuously refined as subsequent projects are brought on-line;
- Identify how the model, through a more detailed assessment of its application to the recommended large-scale demonstration projects in the province, might be transported to the member jurisdictions of the Western Climate Initiative and internationally;
- Implement pilot projects as a risk-appropriate method of implementing IRM, while evaluating and refining the IRM model. Initially emphasise retrofit pilots since these provide initial backup to existing infrastructure, if it proves necessary;
- Consolidate information on all financing programs available for implementing components of IRM in federal, provincial and local levels of government in a single window to expedite access to these programs by developers.

5. The following recommendations apply to improving business case analyses to encourage the full application of IRM

- Change the metrics for evaluating business cases to put resource use, reuse, recovery and net revenues first, so the net impact to the taxpayer is explicit. Include climate change metrics in the business case so sustainability is fully integral to business case models. Flow this through to be part of the transparent (*i.e.* published) evaluation criteria for procuring infrastructure;
- GHG emissions reduction should be used as key performance criteria for all municipal infrastructure, including infrastructure which relates to waste management. Include GHG levels, carbon credits and carbon taxes as evaluation and pricing criteria in both modelling and procurement. This is consistent with the Premier's commitment to the Vancouver Valuation Accord;
- Life cycle costing as currently implemented is mainly focussed on cost savings. It must be replaced by full life cycle valuation, including environmental factors. The value and cost of all components of a model, including any residual value or cost, must be included in models, analyses and evaluation and procurement criteria;
- The economic importance of the IRM approach is also significant. There is an immense opportunity for BC business to develop and apply the technologies outlined in this report. This will require a partnership between the regulatory responsibilities of government and the entrepreneurial skills of the private sector.

Application of IRM to the Capital Region

In the past two months the Capital Regional District has received direction that indicates that the IRM model should be applied to its solid and liquid waste plans following the appropriate engineering and market assessments set out in this report and in the peer reviews. The direction from the Minister of the Environment⁴⁰ states that the CRD should examine:

- Minimising total project costs to taxpayers by maximising...beneficial reuse of resources
- Optimising resource recovery through a more distributed infrastructure model
- Aggressively pursuing reductions in GHG emissions
- Optimising smart growth results by encouraging green development such as Dockside Green
- Integrating liquid and solid waste resource recovery opportunities

In addition, the CRD has recently signed the Climate Action Charter and Community Energy Plan committing it to achieve a 33% reduction in GHGs by 2020.

Full deployment of the IRM model in the Capital Region could potentially result in a reduction of over 23% in GHG emissions assuming that markets can be found for all generated non-fossil-based energy.

The Capital Region could become a leader in implementing IRM as it is committed to resource recovery and IRM could enable it to achieve a tertiary level of wastewater treatment in the timeframe required for secondary treatment by senior government.

The Study Team recommends that the following actions be implemented:

- Integration of liquid and solid waste management plans to include collection of all organic wastes in the Region;
- Adopt resource recovery as a driving component of regional facilities to recover gas, heat and energy from the co-management of solid and liquid waste streams;
- As a starting point, model, design and construct at least three, and ideally six, localised water treatment and heat recovery facilities beginning in 2008 where there is a readily available market for carbon neutral energy to meet the provincial legislative targets;
- One of these pilots should be in James Bay where the sewage infrastructure requires upgrading. It might be possible to establish a wastewater treatment demonstration project in the neighbourhood and use the heat pumps to heat local government offices, commercial establishments and the Legislature (Figure 13 on page 37). Highly treated water could be used to replace potable water for irrigating the Legislature grounds and Beacon Hill Park. Other

⁴⁰ Letter from Barry Penner , Minister of Environment, to the CRD Board, December 14, 2007.

locations for pilots include the University of Victoria, Royal Roads University, and the Department of Defence lands in Esquimalt;

- Access to large amounts of organic wastes from agricultural sources in Central Saanich plus access to the Saanich Peninsula Hospital provides a potential demonstration project to implement the province's bio-energy strategy;
- Rapid development in the West Shore communities provides opportunities for IRM to be applied to new developments, for water reuse from localised treatment plants for golf courses and stream recharge;
- Encourage interested developers in the Region to implement IRM in their proposed developments and work with municipalities to accelerate the adoption of IRM;
- Immediately start an analysis of the extent and nature of deferred maintenance in the Capital Region, including both CRD infrastructure and municipal wastewater collection systems (*e.g.* stormwater overflows, lift stations, piping etc.). Review all analyses of all traditional approaches to these maintenance requirements in light of the IRM model and business case; and
- Create an integrated model and governance structure in the Capital Region and member municipalities to manage both municipal and regional solid, liquid waste and water systems, including operating and maintenance costs.

References

Allen Kani Associates and Enviros RIS Ltd. 2001. WDP Study: Implications of Different Waste Feed Streams (Source-Separated Organics and Mixed Waste) on Collection Options and Anaerobic Digestion Processing Facility Design, Equipment and Costs. Prepared for the City of Toronto. 40pp.

Arkay, K. and C. Blais. 1999. The District Energy Option in Canada. Community Energy Technologies (CET), CANMET, Natural Resources Canada.

Associated Engineering B.C. Ltd., CH2M Hill, and KWL. 2007. Core Area Wastewater Management Program: The Path Forward. Prepared for the Capital Regional District. 30pp.

Boyd, M., Murray-Hill, A. and Schaddelee, K. 2004. Biodiesel in British Columbia Feasibility Study Report, Wise Energy p. 46.

Brundtland Commission "[*Report of the World Commission on Environment and Development*](#)", United Nations, 11 December 1987.

Canadian Council of Ministers of the Environment. 2006. Canadian Council of Ministers of the Environment. 19pp.

Canadian Council of Ministers of the Environment. 2006. Review of the State of Knowledge of Municipal Effluent Science and Research. 94pp.

Canadian Council of Ministers of the Environment. October, 2007. Draft Canada-wide Strategy for Managing Municipal Wastewater Effluent. 288pp.

Canadian Council of Ministers of the Environment. 2006. Comparative Cost Template for Various Levels of Municipal Wastewater Treatment prepared by CBCL Limited Consulting Engineers. 89pp.

Capital Regional District. 2000. Capital Regional District Summary of Current and Projected Sanitary Flows, Version 2: With I&I Strategy #3. p. 54.

Capital Regional District. 2001. Summary of Phase 1 and Phase 2 Solid Waste Composition Study, December 2001. 48pp.

Capital Regional District. 2003. Macaulay and Clover Point Wastewater and Marine Environment Program: 2003 Annual Report. 154pp.

Capital Regional District. 2003. 2002 Annual Overview of Greater Victoria's Drinking Water Quality. 41 pages.

Capital Regional District. Water Advisory Committee. April 2003. Recycling Water: A Conservation Strategy for the 21st Century. 48pp.

Capital Regional District. 2006. Solid Waste Division: 2006 Annual Report. 16pp.

Capital Regional District. 2006. 2006 State of the Environment Indicators Report. 82pp.

Capital Regional District. January 8, 2007. Core Area and West Shore Sewage Treatment Decision Information Report - Design Criteria. 14pp.

Capital Regional District. 2007. Report to Environment Committee Meeting of Wednesday, 28 February 2007. Subject Hartland Landfill Greenhouse Gas Emission Reduction Credits.

Capital Regional District. 2007. Report to the Environment Committee Meeting of Wednesday, 23 May 2007. Report #ESW 07-42.

City of Toronto. 2001. WDO Study: Implications of Different Waste Feed Streams (Source-Separated Organics and Mixed Waste) On Collection Options and Anaerobic Digestion Processing Facility Design, Equipment and Costs.

Cocivera, M. 2006. Re-inventing the Wheel: Designing New Infrastructure for the Energy Harvesting Age. Master of Architecture Thesis, Dalhousie University, Halifax, Nova Scotia. p. 56.

Crane, D. 2004. Case study in the use of reclaimed water systems: Irvine (Calif.) Ranch Water District. Home Builders' Association of Metro Denver. <http://www.builtgreen.org/articles/0305e_water.htm>. Accessed: October 31, 2007.

Daigger, G.T. and Crawford, G.V. 2006. Enhancing water system security and sustainability by incorporating centralized and decentralized water reclamation and reuse into urban water management systems. *Journal of Environmental Engineering and Management*, 17(1), 1-10 (2007). 10pp.

Davidsson, A., C. Gruvberger, T. Christensen, T. Hansen, and J. Jansen. 2006. Methane yield in source-sorted organic fraction of municipal solid waste. *Waste Management*. 27 (3): 406-414.

Edelmann, W., H. Engeli, and M. Gradenecker. 2000. Co-digestion of organic solid waste and sludge from sewage treatment. *Water Science and Technology*. 41 (3): 213-221.

Environment Canada. 2001. Canada's Greenhouse Gas Inventory 1990 -1999 Emission and Removal Estimation Practices and Methods. 8pp. Available at:
<http://www.ec.gc.ca/pdb/ghg/inventory_report/1990_99_report/sec2_6_e.cfm#link140>

Florida Department of Environmental Protection. 2003. "Water Reuse".
<<http://www.dep.state.fl.us/water/reuse/activity.htm>>. Accessed: September, 2007.

Funamizu, N., M. Iida, Y. Sakakura, and T. Takakuwa. 2001. Reuse of heat energy in wastewater: Implementation examples in Japan. *Water Science and Technology*. 43(10): 277–285.

Ghafoori, E. and P. Flynn. 2006. Optimum Sizing for Anaerobic Digestion. BIOCAP Research Project. Department of Mechanical Engineering, University of Alberta. 31pp.

Gray, Nick. 2004. *Biology of Wastewater Treatment*. Imperial College Press. 1444pp.

Greater Vancouver Regional District. Annacis Island WWTP. <<http://www.gvrd.bc.ca/sewerage/annacis.htm>>. Accessed: October 31, 2007.

Hawken, P., A. Lovins, and L.H. Lovins. 1999. *Natural Capitalism*. Rocky Mountain Institute. Snowmass, CO. 396 pp.

Herlihy, J. 2007. Reclaimed water systems: Can we reduce demand on treated water? Home Builders' Association of Metro Denver. <http://www.builtgreen.org/articles/0305e_water.htm>. 3pp. Accessed: October 31, 2007.

IPCC. 2006. IPCC Guidelines for National Greenhouse Gas Inventories. <<http://www.ipcc-nggip.iges.or.jp/public/2006gl/vol1.htm>>. Accessed: October 31, 2007.

IPCC. 2006. 2006 IPCC Guidelines for National Greenhouse Gas Inventories, Chapter 2: Waste Generation, Composition and Management Data. 26pp.

James, S. and T. Lahti. 2004. *The Natural Step for Communities: How Cities and Towns Can Change to Sustainable Practices*. New Society Publishers. 279 pages.

Jantrania, A. R., and M.A. Gross. 2006. Chapter 5: Effluent dispersal and recycling systems. In: *Advanced onsite wastewater systems technologies*. CRC Press, Taylor and Francis Group. New York. 261 pp.

Mashall, J. 2007. Biorefineries: Curing our addiction to oil. *New Scientist*. July 7-13, 2007. p. 4.

McCarry, Blair. 2007. Resources from Waste Report - Phase One. September 14, 2007.

National Pollutant Release Inventory. 2006. Highwest Waste Recycler Ltd. (NPRI ID 7827). <http://www.ec.gc.ca/pdb/querysite/facility_substance_summary_e.cfm?opt_npri_id=0000007827&opt_report_year=2006>. Accessed: October 31, 2007.

Natural Resources Canada. 2002. Ground-source Heat Pump Market Development Strategy - Executive Summary. <http://www.canren.gc.ca/prod_serv/index.asp?CaId=151&PgId=771>. Accessed: October 31, 2007.

Nelson, K.L. 2005. Small and decentralised systems for wastewater treatment and reuse. National Research Council. 2005. Water conservation, reuse and recycling. Proceedings of an Iranian-American

workshop. Committee on US-Iranian workshop on water conservation and recycling. The National Academies Press. Washington D.C. 279 pp. Pages 54-66.

Pearce, F. 2006. Ecopolis now. *New Scientist*. June 17-23, 2006.

Per Dr. Marta Tendaj, Business Development Manager, Stockholm Vatten on October 9, 2006.

Per Fred Stock, Steam Plant Manager, Tembec, Chetwynd BC, 2006.

Per Lennart Erfors, Coordinator of Climate Change Strategies, Kristianstad Sweden on October 6, 2006

Piasecki, B., D. Rainey, and K. Fletcher. 1998. Is Combustion of Plastics Desirable? *American Scientist*. 86 (4): 364.

Pourkarimi, B. 2007. Energy Savings from Water Efficiency. Prepared For: BC Hydro Power Smart. 85pp.

Province of British Columbia. 2007. Speech from the Throne. The Honourable Iona Campagnolo, Lieutenant-Governor at the Opening of the Third Session, Thirty-Eighth Parliament of the Province of British Columbia, February 13, 2007.

Pym, R.V. 2004. 2003 Compliance Monitoring for Sewage Outfalls Operated by the Capital Regional District of British Columbia, Canada. Prepared for the Capital Regional District. 90pp.

Robert, K-H. 2002. *The Natural Step Story: Seeding a Quiet Revolution*. New Society Publishers. 274 pp.

Sandvig, E. et al. 2003. Integrated Pyrolysis Combined Cycle Biomass Power System Concept Definition Final Report. US Department of Energy. 109 pages.

SENES Consultants Limited. McEwen, B. and Hrebenyk, B. 2006. Greenhouse Gas and Energy Use Inventory for the Capital Region 2004. Prepared for the Capital Regional District. 120pp.

Shirek, M. 2006. Wood Residue to Fuel. *Biomass Magazine*. p. 3.

Shizas, I. and D.M. Bagley. 2004. Experimental Determination of Energy Content of Unknown Organics in Municipal Wastewater Streams. *Journal of Energy Engineering*. 130 (2): 45-53.

Sigenthaler, J. 2004. *Modern Hydronic Heating for Residential and Light Commercial Buildings*. 2nd Edition. Thomson Delmar Learning.

Tchobanoglous, G. 1991 *Wastewater Engineering: Treatment, Disposal and Reuse*. Metcalf and Eddy, Inc-3rd Edition. Revised by George Tchobanoglous, Frank Burton. 1848 pp.

University of Victoria. 2006. Sustainability Report 2006. 20 pp.

Van Wylen, G. J. and R. E. Sonntag. 1976. *Fundamentals of Classical Thermodynamics*. John Wiley & Sons. 760pp.

Washington State Department of Ecology. 2000. *Water reclamation and reuse. The demonstration projects*. Publication Number 00-10-062. 16 pp.

Washington State Department of Ecology. 2005. *Frequently asked questions about reclaimed water use*. Document number 05-10-02. 10 pp.

WISE Energy Coop. 2004. *Biodiesel in British Columbia: Feasibility Study Report*. Prepared for Eco-Literacy Canada. p. 46.

Zábranská, J., M. Dohányos, P. Jeníček, P. Zaplatílková, and J. Kutil. 2002. The contribution of thermophilic anaerobic digestion to the stable operation of wastewater sludge treatment, *Water Science and Technology*. 46 (4-5): 447–453.

Glossary of Terms

ADWF	Average Dry Weather Flow of wastewater
Biogas, raw	Raw biogas is a mixture of 2/3 methane, 1/3 carbon dioxide, and trace sulphur compounds.
Biogas, upgraded	Upgraded biogas is 97%-99% methane, virtually identical to natural gas.
CAMF	Capital Asset Management Framework
Cogeneration	Generation of electricity with internal combustion engines, and using the heat produced for beneficial uses such as space heating.
CBOD	Carbonaceous Biochemical Oxygen Demand
CRD	Capital Regional District
COTS	Commercial Off-the-Shelf equipment, as opposed to custom-made equipment.
DHW	Domestic Hot Water
Effluent	Flows of treated water from a treatment plant
GHG	Greenhouse gas
Highest and Best Use	That use which creates the net optimal value. More traditionally applied to land value in a valuation context but also applicable to business models.
I&I	Inflow and infiltration. Inflow includes the flow of stormwater into sewage pipes (for example from downspouts), and infiltration includes stormwater or groundwater which infiltrates sewage pipes (for example through cracks).
Influent	Flows of raw sewage into a treatment plant
IRM	Integrated Resource Management
Mesophilic range	anaerobic digestion of sludge at temperatures near 35°C
Net Present Value	See NPV.
NPV	Net Present Value, <i>i.e.</i> the value today of future costs and revenues, after adjusting for time, risk and other factors by discounting.
Syngas	Synthesis gas is produced through gasification, in which organic matter is heated with little or no oxygen. Synthesis gas is a mixture of methane, hydrogen, and carbon monoxide.

Thermophilic range anaerobic digestion of sludge at temperatures near 55°C
UVic University of Victoria
WERC Water and Energy Recovery Cell (local water treatment and purification plant)

Technical Appendices



Appendix A: Project Scope

The project scope included:

- A concise description of technologies and how they would be applied in a range of settings (existing urban, existing suburban, redeveloping urban, new suburban, rural residential, rural);
- Accounting for costs, revenues, carbon impact, energy (gas, heat, electrical) and any other aspects identified and deemed suitable for consideration;
- Using triple bottom line as a conceptual method of accounting;
- Assessing fit relative to provincial statutes, targets, policies and processes;
- Analysis using the Capital Regional District as an exemplar to illustrate practical applicability of approaches;
- Identifying potential pilot projects for Integrated Resource Management;
- Some examples of applications and existing uses of the technology;
- A high level costing, including costs potentially avoided and how these compare to traditional approaches, *i.e.*, where you save/ where you spend;
- A high level risk analysis and possible approaches to risk mitigation;
- Conditions required for successful implementation;
- Barriers that need to be addressed (regulatory etc.);
- Suggested communications plan; and,
- International expert peer review of the study, drawing on international expert resources in the respective fields. Note that peer review of the final report will be conducted by the Steering Committee.

While the initial focus of the study is the Capital Region, the primary intent of this study is to address how the approach may be applied more broadly across the Province.

Appendix B: Authors, Contributors and Reviewers

Authors:

- Chris Corps, B.Sc., MRICS
- Stephen Salter, PEng
- Wm. Patrick Lucey, M.Sc., R.P. Bio.
- Jon O’Riordan, Ph.D.

Contributors:

- Cori L. Barraclough, M.Sc., R.P. Bio.
- Judith Cullington, M.A., B.Sc.
- David Jackson, M. Eng., PEng
- Rick Lloyd, PEng
- Bob Landell, LEED™ AP
- Blair McCarry, PEng

Additional support and research was provided by Lighthouse Sustainable Building Centre, in particular by Helen Goodland, Jessica Wooliams, and Jamie Cowan.

Technical advice was provided by a Technical Advisory Committee consisting of:

- Deborah Rasnick, Ministry of Community Services
- Sue-Ann Fimrite and Mark Harrison, Partnerships BC
- Glen Brown, Infrastructure Division, Ministry of Community Services
- Randy Alexander, Environmental Protection Div, Ministry of Environment
- Jack Hull, Water Services Division, CRD
- Dr. Bruce Jank, PEng, CGET, Burlington, Ontario
- Peter Adams, Victoria Consulting Network Ltd

Oversight was provided by the Steering Committee:

- Dale Wall, Ministry of Community Services

- Kelly Daniels, CRD
- Graham Whitmarsh, Climate Action Secretariat
- Lawrence Alexander, Ministry of the Attorney-General

Partnership BC participates as an observer on the Committee.

Expert Review was provided by:

- Dr. David Bagley, P.Eng. Department Head and Associate Professor of Civil and Architectural Engineering, University of Wyoming
- Oliver Brandes, Associate Director and Water Sustainability Project Leader, POLIS Project on Ecological Governance, University of Victoria
- Peter Clark, FRICS, AACI P.App
- Blair McCarry, PEng, LEED™ AP, Principal, Stantec, Vancouver
- Bob Landell, LEED™ AP, Principal, Avalon Mechanical Consultants Ltd., Victoria
- Les McDonald, R.P. Bio. Water Quality Biologist, Senior Impact Assessment Biologist (ret'd). Cranbrook, BC.
- Scott Muldavin, CRE, FRICS. President, The Muldavin Company Executive Director, Green Building Finance Consortium. San Rafael, CA
- Dr. Valerie Nelson. Coalition for Alternative Wastewater Treatment, Gloucester, MA.
- Dr. Vladimir Novotny. CDM Chair Professor and Director, Center for Urban Environmental Studies. Northeastern University. Boston.
- Dr. John Robinson. Institute for Resources, Environment and Sustainability. University of British Columbia.
- Bruce Sampson. Vice President of Sustainability, BC Hydro.
- Dr. Jerry Stonebridge, President- National Onsite Wastewater Recycling Association (NOWRA) Stonebridge Environmental Services, Freeland, WA
- John Thomas. Executive Director Washington Onsite Sewage Association (WOSSA) Tacoma, WA

Authors' Backgrounds

Stephen Salter
PEng

Stephen J. Salter PEng is a professional engineer who graduated from the United World College of the Atlantic, and from UBC's mechanical engineering program in 1982. Stephen held technical and management positions with Babcock & Wilcox, Microtel, and Scott Paper before starting his management consulting practice in 1991. Through Farallon Consultants Limited, Stephen helps industrial clients reduce their environmental impacts, often through conservation or by recovering value from waste.

In October, 2006 Stephen traveled through Sweden to learn how that country recovers energy and other resources from liquid and solid waste. During the visit, federal, regional, and municipal officials explained the economics behind Sweden's integrated resource recovery practices, and how these practices support Sweden's efforts to reduce pollution and curb climate change.

Stephen's role in the Study Team was to describe how biofuels, heat energy, and electricity can be recovered from waste streams, find the synergies among waste streams and potential uses for these resources, estimate the volumes of resources which could be recovered, model the infrastructure needed for resource recovery, and to estimate the cost of this infrastructure.

Chris Corps
BSc, MRICS

Chris Corps is Principal of Asset Strategies, providing consulting on development, finance, and real estate implementation with a focus on value enhancement. With more than 25 years experience on large and small projects including Coal Harbour, False Creek and London's Canary Wharf, he had a key role in BC's first approved off-book P3 and created the business case and co-led changes to seniors care in BC.

Chris initiated and led Green Value, a 2005 international study on sustainable value, is a Board member of Vancouver's Light House Sustainable Building Centre and Green Building Finance Consortium, initiated and led the Vancouver Valuation Accord (linking sustainability and value), and is an author to the Commission for Environmental Cooperation. He is co-founding signatory of the Toronto Valuation Accord, strategic advisor to the National Executive Forum on Public Property, is a Chartered Surveyor and past Chairman of Royal Institution of Chartered Surveyors (Canada), being one of twelve involved in forming the profession's international strategy. He is Chair of RICS America's Sustainability Council and member of RICS' International Valuation Sustainability Group.

Wm. Patrick
Lucey, M.Sc.,
R.P. Bio.

Patrick Lucey is a principal of Aqua-Tex Scientific Consulting Ltd., a specialised company engaged in leading-edge integrated water management, ecological site planning, restoration and protection of functional aquatic habitat. He works with both public sector agencies and private developers to manage development in a manner that protects the long-term needs of aquatic systems and the people who depend on them.

Patrick has a background in resource management geography, political science, marine biology and freshwater ecology. He continues to supervise graduate students in freshwater ecology and ecological economics at the University of Victoria where he lectured and managed a research lab for over 15 years. He has spent decades conducting research and monitoring within the urban watersheds of the CRD and served on several CRD Water advisory committees. He has been a design team member of many significant green development projects including the Vancouver Island Technology Park, (the first LEED™ green building in Canada), Dockside Green, and the Vancouver 2010 Olympic Village (both public and private sector components). He is member of the Canada Green Building Council LEED™ Technical Advisory Committee and is currently consulting to British Pacific Properties to design the Rogers Creek Neighbourhood and Village Centre, on the slopes of West Vancouver, as part of their plan for the next 100 years of development.

Patrick's role on the Study Team was to provide advice and vision for fully integrated 'Water' management including wastewater, stormwater, drinking water, rainwater and water to support ecological services, on both a conceptual and practical level.

Jon O'Riordan,
Ph.D.

MA, PhD. Jon O'Riordan is a resource planner and manager who has completed 35 years in the public service at the federal and provincial levels of government. He was Assistant Deputy Minister in the BC Ministry of Environment for 10 years and was appointed as Deputy Minister for the Ministry of Sustainable Resource Management in 2001. Since retiring from the public service in 2004, he has been appointed as Adjunct Professor in the Faculty of Interdisciplinary Studies at UBC where he teaches a course on resource planning, sustainability and governance. He is a member of the CRD Roundtable on the Environment and is active in the Whole City Change program initiated by the Gaining Ground Sustainable Development Summit.

Jon chaired the Study Team and acted as a liaison between the Study Team and the Steering Committee advising on government policy and regulations.

Appendix C: Government Policies and Commitments

IRM projects in BC will mostly be driven by local governments, but larger projects will likely include contributions from provincial and federal agencies. It is thus desirable to consider government policy and other aspects at federal, provincial, regional and municipal levels, many of which have been below. The non-financial evaluation included a desktop review of current policies of the federal, provincial, and local governments, which can be assessed as part of the triple-bottom line approach to ensure that choices are consistent with these policies.

Federal Government Goals and Policies

Infrastructure Canada website

Delivering sustainable infrastructure such as ...water treatment and wastewater plants...is essential to competing internationally and supporting the well-being of Canadians

An important aspect of Infrastructure Canada's mandate is the enhancement of the national infrastructure knowledge base and the creation of better operations management and investment decision making tools

Environment Canada mandate http://www.ec.gc.ca/sd-dd_consult/PDF/SDS2007_e.pdf

The preservation and enhancement of the quality of the natural environment, including water, air and soil quality

Federal Sustainable Development Strategy 2007-2009 goals http://www.ec.gc.ca/sd-dd_consult/PDF/SDS2007_e.pdf

Clean and secure water for people, marine and freshwater ecosystems

Clean air for people to breathe and ecosystems to function well

Reduce greenhouse gas emissions

Communities enjoy a prosperous economy, a vibrant and equitable society, and a healthy environment for current and future generations

Sustainable development and use of natural resources (Reduce adverse effects on ecosystem and public health from the use of resources)

Strengthen federal governance and decision making to support sustainable development

Health Canada objective

Prevent and reduce risks to individual health and the overall environment

PM APEC speech

Increase investment in energy science and technology

Inject more clean and renewable energy into our economy

Increase energy efficiency

Provincial Government Goals and Policies

Five Great Goals

- To make B.C. the best educated, most literate jurisdiction on the continent
- To lead the way in North America in healthy living and physical fitness
- To build the best system of support in Canada for persons with disabilities, special needs, children at risk and seniors
- To lead the world in sustainable environmental management, with the best air and water quality, and the best fisheries management, bar none
- To create more jobs per capita than anywhere else in Canada

Greenhouse Gas Reduction Targets Act

The following targets are established for the purpose of reducing BC greenhouse gas emissions:

(a) by 2020 and for each subsequent calendar year, BC greenhouse gas emissions will be at least 33% less than the level of those emissions in 2007;

(b) by 2050 and for each subsequent calendar year, BC greenhouse gas emissions will be at least 80% less than the level of those emissions in 2007.

By December 31, 2008, the minister must, by order, establish BC greenhouse gas emissions targets for 2012 and 2016.

Beginning with a report on 2008 BC greenhouse gas emissions, and continuing with a report for every subsequent even-numbered calendar year, the minister must, as soon as reasonably practicable for each year, make public a report respecting: (a) a determination of the BC greenhouse gas emissions level for the relevant calendar year, (b) the progress that has been made toward achieving the targets under section 2, (c) the actions that have been taken to achieve that progress, and (d) the plans to continue that progress.

Each public sector organization must be carbon neutral for the 2010 calendar year and for each subsequent calendar year.

Throne Speech Feb 2007

To reduce B.C.'s greenhouse gas emissions by at least 33 per cent below current levels by 2020. This will place British Columbia's greenhouse gas emissions at 10 per cent under 1990 levels by 2020

Leaders from business, community groups, and citizens themselves are calling for a new environmental playing field that is fair and balanced but that recognises we all need to change. We all need to be part of the solution.

Our actions will mean more jobs, new investments, and ultimately greater prosperity for British Columbia. Climate action must be seen and pursued as an economic opportunity as well as an environmental imperative.

Being bold and far sighted will foster innovation, new technologies, and plant the seeds of success.

Your government will look to all forms of clean, alternative energy in meeting British Columbians' needs in our provincial economy. Bioenergy, geothermal energy, tidal, run-of-the-river, solar, and wind power are all potential energy sources in a clean, renewable, low-carbon future.

Transportation represents about 40 per cent of B.C.'s total greenhouse gas emissions.

New measures will also be taken to reduce energy consumption and emissions in the public sector

Conservation is key to a greener future. Public education and information is critical in that regard

The new Green Cities Project will foster innovations that reduce our imprint on the planet through sustainable community planning

The government will unleash our Pacific promise as a budding powerhouse of clean, renewable energy; profitable, sustainable forestry; world-leading technology; high-quality manufacturing; value-added agricultural products; award-winning wines; world-class mineral deposits; and superb tourism destinations

Premier's Speech to UBCM October 2007

Next spring, we will act to make greenhouse gas emission reduction strategies and targets a legal requirement of all official community plans and regional growth strategies

We're going to provide new authority to use development cost charges as a way to encourage green development, small-unit housing and small-lot subdivision. You should have the power to waive those charges for any development that you feel will help you meet your goals of a greener community.

The way to reduce costs is to reward green developments with faster approvals and strategies that allow the purchasers of those homes and buildings to avoid costs for municipal services that they won't use. Let's encourage people to have their own sewage treatment. Let's make sure that we're helping them to conserve water and energy. We need to find new ways of taking costs off of green development that will make housing more affordable and save everyone money, not the opposite.

Reduce our greenhouse gas emissions between 24 and 33 million tonnes—that's enough to get us 60 to 80 per cent of the way toward our target of 33 per cent greenhouse gas emissions reduction by 2020.

We will legally require our province to reduce greenhouse gas emissions by 33 per cent below current levels by 2020. A legal target will also be set for 2050. The bill will require us to establish legally binding emission reduction targets for 2012 and 2016 by the December 31, 2008.

Through the intent of the Climate Action Charter, we encourage all local governments to become carbon-neutral by 2012.

There are enormous opportunities in innovation and new technologies. That's what the new \$25-million innovative clean energy fund was established to help support, and our new energy plan is centred on changing the way we deal with energy. It focuses on conservation and the need to make British Columbia energy self-sufficient by 2016.

We also plan to enact stringent new measures to regulate landfill gases. We'll work closely with the UBCM and others to establish a sensible, rigorous regime for the recovery, sale and use of methane gas from landfills. And while talking about capturing the methane in landfills, we also need to think about reducing the long distance trucking of garbage to landfills.

Under our plan all new electricity produced will need to have zero greenhouse gas emissions, and all existing power generation will be required to have net zero greenhouse gases by 2016.

BC Energy Plan http://www.energyplan.gov.bc.ca/PDF/BC_Energy_Plan_Conservation.pdf

Set an ambitious conservation target, to acquire 50 per cent of BC Hydro's incremental resource needs through conservation by 2020

Ensure a coordinated approach to conservation and efficiency is actively pursued in British Columbia.

Encourage utilities to pursue cost effective and competitive demand side management opportunities

New provincial public sector buildings will be required to integrate environmental design to achieve the highest standards for greenhouse gas emission reductions, water conservation and other building performance results such as a certified standard

The Community Action on Energy Efficiency (CAEE) program provides financial and research support to BC local governments to advance the energy conservation and efficiency through local government policies and public outreach

Implement a provincial Bioenergy Strategy which will build upon British Columbia's natural bioenergy resource advantages

Province will be electricity self-sufficient by 2016.

Western Climate Initiative

Setting an overall regional goal by August 2007 to reduce emissions from the province and the states collectively, consistent with state-by-state and provincial goals;

Developing, within 18 months of the effective date of the agreement (August 2008), a design for a regional market-based multi-sector mechanism to achieve the regional GHG reduction goal; and

Participating in a multi-state/provincial GHG registry to enable tracking, management, and crediting for entities that reduce GHG emissions, consistent with the state/provincial GHG reporting mechanisms and requirements.

2008 Throne Speech

This speech unveiled the LiveSmart BC initiative. It provides for a range of activities that support low carbon communities such as :

- Reduce life cycle cost and increase long term benefits of resource use
- Green developments to be fast tracked
- Green building code to conserve water and energy
- Convert brownfields to greenfields through redevelopment using IRM principles
- Establishment of clean energy fund
- Establish verifiable BC offset project that will increase energy efficiency, support renewable energy, increase carbon capture and sequestration

The IRM model is ideally suited to implement all these LiveSmart BC initiatives

Budget 2008-02-19

Commitment for instituting a progressive carbon tax on fossil based fuel usage starting on July 1 2008 and increasing each year for three years

An investment over four years of \$1 billion in low carbon initiatives, energy conservation, bioenergy research and implement new regulatory requirements

Provincial Bio Energy Strategy 2008-01-31

Creation of a Bioenergy Network with a grant of \$ 25 million to encourage the development of pilot and demonstration projects

Provision of \$ 10 million for funding biodeisel production

MEMPR Service Plan Objective 2.2 2007

Increased energy conservation and use of alternative, clean energy and efficient technologies

Ministry of Community Services Service Plan 2007

Local governments are accountable and make effective use of their legislative powers

Planning and infrastructure investments contribute to community sustainability.

Enhanced protection and stewardship of our water resources

Healthy air quality

Effective responses to climate change

Healthy and diverse native species and ecosystems

Sustainable use and continued benefits of water and air (Number of water or watershed management plans completed and implemented)

Ministry of Economic Development Service Plan 2007

All British Columbians live in prosperous regions and are able to achieve their economic potential

Ministry of Community Services Local Government Infrastructure Grants

Assist municipalities and regional districts to address high priority health and environmental concerns by funding projects that remove health hazards or provide improved environmental protection

Ministry of Community Services Local Government Department Wastewater Planning

Protect public health

Protect the environment from potentially adverse effects of wastewater

Ministry of Health Drinking Water Program mandate

Ensuring safe, reliable and accessible drinking water for all British Columbians

Ministry of Environment Environmental Management Branch mandate

This branch is responsible for the design, development, implementation and evaluation of a wide array of pollution prevention and remediation activities throughout British Columbia to fulfil its goal of preventing pollution at source and remediating where necessary

Ministry of Environment LWMP guidelines <http://www.env.gov.bc.ca/epd/epdpa/mpp/gfdalwmp.html#23>

For a secondary treatment process to operate correctly, a good source control program is essential. Infiltration and inflows must be controlled. Failure to do so will result in process upsets, toxic effluent and contaminated sludges.

Secondary treated effluent can be economically reused or recycled as irrigation water, industrial process or cooling water, and to develop wetlands, ponds, etc. Sewage sludge recovers nutrients and organics which can be used as fertiliser and organic soil conditioner, and to produce topsoil for disturbed lands.

The Ministry of Environment has adopted the "5Rs" as guiding factors in its approach to waste management. The 5Rs entail Reduction, Reuse, Recycling, Recovery, and Residual management. The first 2Rs, Reduce and Reuse, are the most important, and should be given the highest priority. Recycling and utilising waste materials can have long-term economic and social benefits. For instance, it may be preferable to treat the sewage in satellite plants for reuse as irrigation water on surrounding forests, farmland, or community facilities such as parks, golf courses and boulevards, even though this may incur additional costs. Similar arguments can be made for recycling sewage effluent for its nutrient content, or recycling sludge for its humus and nutrient content.

All cost effective alternative waste treatment and disposal methods should be fully evaluated. Monetary costs should be calculated in terms of present dollar values or equivalent annual values over the planning period

When the (LWM) plan is presented to the public for review, it is prudent to present all alternatives in an easy-to-understand format clearly showing advantages and disadvantages of each option. Cost information should be broken down to individual households and industrial/commercial taxpayers

BC Climate Charter (signed by the Province, UBCM and signatory local governments)

Local governments agree to develop strategies and take actions to achieve the following goals:

- Being carbon neutral in respect of their operations by 2012, recognising that solid waste facilities regulated under the Environmental Management Act are not being included in operations for the purposes of this Charter;
- Measuring and reporting on their community's GHG emissions profile; and
- Creating complete, compact, more energy efficient rural and urban communities (*e.g.*, foster a built environment that supports a reduction in car dependency and energy use, establishes policies and processes that support fast tracking of green development projects, adopt zoning practices that encourage land use patterns that increase density and reduce sprawl).

The Province and UBCM will support local governments in pursuing these goals, including developing options and actions for local government to be carbon neutral in respect of their operations by 2012.

CRD Goals and Policies

CRD Strategic Plan 2007 http://crd.bc.ca/about/documents/strategicplan_web.pdf

CRD Values and Operating Philosophy: good governance and visionary leadership; mutual respect and collaboration; strategic, focused and outcome driven; open minded, flexible, innovative and entrepreneurial; accountable, productive and fiscally responsible; a valued resource to our local government partners; open, transparent conduct of business; commitment to the triple bottom line

Regional Transportation outcome: An effective and efficient transportation system consistent with the Regional Vision

Liquid Waste/Sewage outcomes: A balanced approach to liquid waste control; Safe and healthy operation of on-site septic systems; Improved Core Area effluent quality; Exemplary liquid waste control at all CRD facilities; Public understanding of sewage issues and LWMP positions

Emergency response outcomes include: Reduced risk to residents, property and the environment in the event of a significant emergency or disaster

Environmental Protection outcomes include: Watersheds protected to ensure quality water supply and a healthy ecosystem; Environmentally and economically responsible management of the region's solid waste; Reduced Greenhouse Gas (GHG) emissions;

Establish an environmentally and economically responsible sewage treatment system for the region

Become leaders in environmental stewardship through protection, sustainable development and climate change initiatives

CRD Core Area LWMP 2003

Provide for secondary treatment or better for flow up to two times average dry weather flow (ADWF), and primary treatment or better for flow in excess of two times ADWF, up to four times ADWF

Protect the environment and human health from the impacts of liquid wastes (sewage)

CRD Source Control Program objectives

Protect the marine receiving environment adjacent to the CRD's sewage outfalls

ensure that the health and safety of sewage workers and the general public is not put at risk due to the presence of contaminants in wastewater

protect the quality of sewage sludge (biosolids) to allow the full range of options for its beneficial use

ensure fair and balanced use of the CRD's sewerage facilities through education, regulation, enforcement and the application of the user-pay principle

promote responsible pollution prevention practices, including reduction, reuse, recycling, recovery and residuals management

CRD Wastewater website

Provide cost effective, innovative and environmentally responsible wastewater treatment to residents

CRD Community Energy Plan

No net increase in total energy use, even with population growth

CRD Water Conservation website

CRD Water Services encourages the wise and efficient use of water through education, financial incentives, policy measures and research for both residents and businesses

CRD Regional Growth Strategy

Keep Urban Settlement Compact: Locate a minimum of 90% of the region's cumulative new dwelling units to 2026 within the Regional Urban Containment and Servicing area

Manage Natural Resources and the Environment Sustainably: Waste discharges of all types should not exceed the assimilative capacity of the natural environment (including land, air and water);

Consumption of scarce renewable and non-renewable resources should be minimised through conservation, efficiency and application of reduce, reuse and recycle practices; and, IV. Decision-making should give first priority to options that maintain ecosystem health and support the ongoing ability of natural systems to sustain life.

Increase Transportation Choice: A sustainable transportation system...Limits emissions and waste, encourages efficient methods of energy consumption, re-uses and recycles its components, minimises the use of land and reduces the generation of noise and other pollutants

Strengthen the Regional Economy (including Actions to attract and cultivate new firms, business and industry sectors to increase diversity in the regional economy)

CRD SWHP website

The Stormwater, Harbours & Watersheds Program (SHWP) works with municipalities and the community to maintain healthy watersheds and protect the near shore receiving environment...through reducing stormwater contamination and improving overall watershed function

CRD LID website

Low impact development is a stormwater management and land development strategy applied at the parcel and subdivision scale that emphasises conservation and use of on-site natural features integrated with engineered, small-scale hydrologic controls to more closely mimic pre-development hydrology. The goal of LID is to prevent measurable harm to streams, lakes, wetlands and other natural aquatic systems from commercial, residential or industrial development sites

Municipal Goals and Policies

City of Victoria OCP

To promote diversity of opportunity for a range of people to live, work and play

To develop a safe secure, healthy and accessible environment

Establish regional economic development objectives to promote economic activity in a manner which is mutually compatible with neighbourhood plan objectives and the needs of long term sustainability

Explore opportunities for environmental innovations, such as industrial ecology, recycling, market development zones and green business initiatives

Sustain, enhance and promote those elements which contribute to quality of the environment as an inducement for tourism, retirement and industrial development

Encourage innovation and enterprise toward diversifying Victoria's economic base

To encourage the establishment and expansion of new industries which are particularly suited to Victoria, *e.g.*, emerging areas in new technology, particularly marine technology

To improve water quality in offshore and inland waters, including the Outer, Inner and Working Harbour reaches

To provide an adequate and pure source of potable drinking water

City, CRD and Government of Canada should cooperate to achieve a high standard of water quality in Juan de Fuca Strait and Victoria Harbour

To develop and maintain a good level of utilities services for the developed community, recognising those areas subject to change

Make land use decisions compatible with servicing capacities and coordinate upgrading programs with land use policies

Encourage and assist the CRD with solid waste disposal program

Monitor policies to ensure an adequate and prime source of potable drinking water

City of Victoria Water and Environment Division mission, Business Plan 2005

We are dedicated to providing and improving liquid waste collection, stormwater disposal, and drinking water distribution. We provide environmental stewardship in a safe, innovative, cost effective, and responsible way to residents, businesses and other clients

Stormwater Collection System: The objective of this program is to supply facilities throughout the Municipality for the collection and disposal of stormwater runoffs. This program ensures that collected stormwater is disposed of appropriately, thereby minimising any impact on the environment as a result of quantity and quality. The collection, transmission, and disposal of stormwater are fundamental in providing the residence and business with a safe and liveable community.

Sanitary Sewer Collection System: This program is designed to protect the environment and human health from the impacts of liquid wastes (sewage) generated as a result of human occupation and development. The safe collection, transmission, and disposal of sewage is fundamental to the health, safety, and vitality of the community and the surrounding environment.

The Victoria and Esquimalt Water Distribution System: The program objective is to deliver clean, safe and aesthetically pleasing potable water, in accordance with the Provincial Drinking Water Protection Act. The water is for the purpose of domestic consumption and fire fighting. The delivery of clean water, in sufficient quantities, is the foundation for health, growth, safety and economic sustainability within our community.

District of Saanich General Plan, Vision

The ethic of community stewardship is paramount incorporating careful management of public assets and private developments

Efficient and reliable public services, programs, and utilities are provided and maintained through a systematic approach to infrastructure management.

The successful promotion of vibrant, diverse economic development has allowed the municipality to support initiatives to ensure a clean environment.

Natural watercourses are protected and enhanced

Investigate options for liquid waste disposal (including sewage treatment)

Public works will conserve energy, enhance resource use and be environmentally sensitive

District of Saanich Green Building Policy

Green buildings are designed and constructed to maximise efficiency and comfort, without sacrificing style and beauty. Green buildings reduce the need for resources such as energy and water, thus reducing the environmental impact of buildings overall. Healthier for the occupants and cheaper to maintain, green buildings are a community asset.

Township of Esquimalt OCP

Encourage innovative sewage management practices

Repair or replace the sanitary sewer system to reduce sewage pollution into storm drains

To encourage business diversity and community service infrastructure that supports community interaction and helps build sustainable community partnerships

To develop and promote a healthy economic climate in which residents and businesses can prosper and take pride

To protect and enhance the natural environment while accommodating change and development

North Saanich Strategic Plan 2006-09

Reduction of public and/or environmental health risk related to water and waste management

City of Colwood draft Strategic Plan 2007-2011

Colwood Strategic Objectives include : Protect the environment; support land and economic development, improve transportation links and nodes; match infrastructure to the need

Appendix D: Waste Treatment Technologies

The Treatment Process

Sewage must be treated before water and energy can be recovered. The Study Team has developed a conceptual model for a distributed sewage treatment network, comprised of several small, decentralised plants. This decentralised approach allows the plants to be located close to their clients for recovered energy and reclaimed water.

The optimum capacities of decentralised plants will depend on several characteristics of the host community including population density, the condition and type of existing collection system infrastructure, topography and availability and location of resource recovery clients.

These small, decentralised plants could be located on or near existing sewage lift stations, taking advantage of existing infrastructure, rights of way, and land already owned by municipalities. Preferably, they would be interconnected by both control communications and resource transfer lines. This system could be thought of as "the internet of sewage treatment", analogous to many interconnected machines working together, as opposed to a single machine (mainframe computer, or centralised treatment plant in this case). Like other networks, a distributed network of small treatment plants has the potential to be more robust in the event of failures of individual pieces of equipment. The plants could be monitored and controlled automatically and remotely, and if equipment in one plant fails, its load could be transferred to downstream plants.

The general philosophy toward management of sewage in the proposed model is to "work backward" from the opportunities and constraints posed by the local natural environment and potential resource clients and define the levels and types of treatment appropriate for the ultimate dispositions of the reclaimed water. This can will result in different levels of treatment at different locations and even multiple quality levels and types of treatment at one location.

Implicit in the model is the recognition that natural methods of quality improvement are preferred and should be implemented to the full extent that the approaches are feasible. Natural methods can provide quality improvement with fewer inputs of energy, materials and manpower and therefore optimise the net resource flows. For example, natural systems can avoid or minimise the significant energy costs associated with supplying air for biological oxidation. Elimination of residual organic compounds such as pharmaceuticals, which are the newest focus of the wastewater quality industry may be efficiently

accomplished by soil infiltration⁴¹ whereas the mechanical solutions (for example, free radical generation through advanced oxidation) require considerable inputs of energy, capital and perhaps chemicals.

Creative landscape design can maximise opportunities for natural treatment and assimilation and this can have dramatic environmental benefits, as outlined in Appendix E, however, the generally space-intensive nature of natural solutions limits their application in dense urban environments. It is a complex matter to estimate the potential for natural assimilation in any given area and the result will vary considerably from location to location. Consequently, our model assumes the conservative or “worst case” situation whereby 100% of the sewage must be treated to a high “reclaimed water” standard in mechanical plants. These plants intensify the same types of biological processes that would occur in natural systems.

The following is a description of the conceptual design for a localised treatment plant in the Capital Region, named by the Study Team as "Water and Energy Recovery Cells", or sewage WERCs. Each plant is designed to use "commercial-off-the-shelf" equipment which has a stable performance record in other locations. For the Capital Region example, we have looked at plants with a capacity of 2,000 m³/day, along with a smaller number of higher capacity plants (20,000 m³/day, 10,000 m³/day and 5,000 m³/day). To help understand the scale of the plants, the 2,000 m³/day plant would handle the sewage from 6,000 to 8,000 people,⁴² and would require a footprint of 300 m² (over 3,000 square feet).

Water and Energy Recovery Cells (WERCs)

Design objectives for WERCs are to:

- Reclaim water for local use or discharge;
- Facilitate opportunities to reclaim heat from the water for district heating;
- Maximise the recovery of biomass from the wastewater;
- Produce treated water to the standards described in *Figure 17: Treated Wastewater Quality Objectives*; and
- Treat influent flows with the properties described in Appendix B and Appendix C of the CRD's *2003 Compliance Monitoring for Sewage Outfalls Operated by the Capital Regional District of British Columbia, Canada*.⁴³

⁴¹ Presentation by Dr George Tchobanoglous of UC Davis at the 13th Northwest On-Site Wastewater Treatment Short Course and Equipment Exhibition. University of Washington September 19-20, 2005.

⁴² Assuming a 333 litres of wastewater per person per day. Advanced water conservation measures would result in a higher service population.

⁴³ The 2003 report is used, since the Macaulay Pt. flow meter did not operate reliably in 2004-2005 (reference email from CRD, May 8, 2006).

Figure 17: Treated Wastewater Quality Objectives

Parameter	Units	Standard	Notes
Oxygen, Dissolved	mg/L	5.5	Monthly arithmetic mean of weekly samples
pH		6.5-9.0	
CBOD (5 day)	mg/L	10	Monthly arithmetic mean of weekly samples
TSS	mg/L	10	Monthly arithmetic mean of weekly samples
TP	mg/L	0.5	Quarterly arithmetic mean of monthly samples
TN	mg/L	5	Quarterly arithmetic mean of monthly samples
NH3-N	mg/L	1	Quarterly arithmetic mean of monthly samples
Turbidity	NTU	5	24-hr average
	NTU	2	Instantaneous
Fecal Coliform	CFU/100 ml	0	Normally zero counts
	CFU/100 ml	2.2	Median of last 7 samples
	CFU/100 ml	14	Maximum value

Design considerations will include:

- “Green” design—energy efficiency, minimum chemical usage, etc.;
- Compact and able to be inserted unobtrusively into various urban and suburban locations;
- Able to meet specific water quality standards for local uses;
- Appropriate technology for the scale, minimum requirement for operator intervention;
- Tolerant of the peak flows and infiltration and inflow (I&I) characteristic of the many sewer systems.

Design and location would meet the following criteria:

- Locate the WERCs principally at lift stations in the existing sewer network, replacing the existing pumps with new screens and pumps and building the WERCs at or near the lift stations;
- Employ technology to allow a small and flexible footprint for the WERC, so that the plant may be installed in small, inconspicuous, low value spaces, preferably subsurface construction within existing rights of way;
- Intercept and manage 100% of the flow at that location—suspend use of downstream piping and effectively retire many large diameter sewer lines and lift stations;
- Collect biomass at each WERC, but do not generate biogas at each station—transfer biomass to major WERC plants where biogas can be economically generated. Biomass transfer can be effected by subsurface slurry pipeline or truck collection route. External sources of biomass could be received at each WERC (*e.g.*, solid organic waste from the community);

- Where practical, insert comparatively small diameter plastic tubing into “retired” downstream sewer lines as inter-station transfer lines for biomass slurry, screened effluent and possibly reclaimed water. These lines provide recourse in case one WERC malfunctions; and,
- Reliability is achieved through process simplicity, redundancy of key components and “distributed processing” whereby screened sewage received at one WERC may be redirected to other plants in case of emergency. To this end, each WERC would have an extra 25% reserve capacity. For example, the “2,000 m³/day” plant will actually process 2,500 m³/day. Each WERC would have 100% redundancy and backup power on screen equipment, screened effluent pumps and Equalisation (EQ) tank pumps so that the screened effluent transfer line could be a relatively small diameter pipe.
- The total wastewater treatment capacity in the IRM model was 210,000 m³/day, based on twice the ADWF (Average Dry Weather Flow) value of 105,000 m³/day in the Core Area. Since the IRM model is based on just-in-time implementation of new treatment capacity, additional treatment capacity would be added as required. In this approach the capacity and cost of treatment match the current needs of the community.
- The WERC is assumed to handle peak flows (as multiples of ADWF) as follows through a combination of redundant capacity, flow equalisation and accelerated processing of dilute wastewater: screening 500%, primary, secondary and tertiary 400%. These represent large I&I coefficients and it may be more cost-effective in many cases to implement a prioritised I&I control program to reduce plant capital cost. Improved I&I control also increases the sewage temperature, which makes energy recovery economics more favourable. The proximity of the plant may allow more convenient remediation measures in some circumstances.
- The total estimated capital cost of the WERCs was approximately \$2,350 per m³/day of capacity in 2007 dollars, and approximately \$2,930 per m³/day of capacity after accounting for contingencies and inflation to the mid-point of construction. Those who are interested in the capital and operating costs of wastewater treatment plants could contact the Ministry of Community Services for their historical cost data, based on recent expenditures by BC municipalities.

Process Description

The process configuration depicted in *Figure 18: Water Reclamation Station Schematic* and described below is one of several possible configurations identified by the Study Team. Further study will be required to identify the optimum design. This configuration employs only generic technologies, with several possible suppliers for each major process component. Other configurations employing certain proprietary technologies, offer the prospect of further reductions in size and energy requirements, and should be evaluated in the next phase of the study.

- Sewage enters the lift station through one or more pipes with a new sealed connection to a rotary coarse screen (5-6 mm spacing) that removes, washes and compacts trash and lifts it to the surface where it falls into a trash bin.

- The screened wastewater falls into the lift station and is pumped to the Primary Solids Recovery (PSR) unit, with a low dosage of organic polymer added and mixed into the stream enroute. In times of high flow, excess wastewater is directed to the Equalisation (EQ) tank to be stored until flows subside, when EQ tank pumps (under supervisory process control) send accumulated wastewater to the PSR device. The use of an EQ tank in this way dampens the diurnal variations in flow and ensures a reasonably steady flow to the downstream process.
- Screened wastewater is pumped from the lift station to the PSR. In the PSR, most of the particulate matter remaining in the water is removed as a dense slurry or dewatered sludge (as desired). The PSR can be a self-cleaning rotary fine screen, a dynamic sand filter, a dissolved air flotation unit or an enhanced settling device. Very little particulate matter will be left in the PSR effluent. Clarified effluent from the PSR falls into the first (anoxic) compartment of the bioreactor, where the effluent is mixed with nitrified effluent from the last stage of the bioreactor so as to effect biological denitrification.
- Effluent from the anoxic compartment enters the second and third bioreactor compartments, arranged in series. In one of the possible configurations, both compartments contain a large fill fraction (70%) of high surface area mobile media which carry large concentrations of biomass in the form of biofilm. The second compartment primarily digests biodegradable organic matter (CBOD) while the third primarily converts ammonia to nitrate. Both compartments are provided with air supply. Much of the soluble organic matter is converted into biomass, for subsequent recovery. The bioreactor is equipped with an integral biosolids removal device (not shown) to remove biomass from the bioreactor and return it to the PSR as a thin slurry, thus maintaining consistently low solids concentrations in the bioreactor. The Bioreactor could be a Moving Bed Bioreactor (MBBR), a Fluidised Bed Bioreactor (FBB) or an integrated FBB/dynamic sand filter. A Membrane Bioreactor (MBR) could be considered as a replacement for the Bioreactor and Fine Filtration device provided that improvements in energy efficiency can be attained and flux rates can accommodate prevailing I&I conditions.
- Effluent for the bioreactor (containing some sloughed biomass) is pumped from the last compartment, with some sent as recycle back to the anoxic zone and the balance to the Secondary Solids Removal (SSR) device where particulate matter is removed. The SSR could be a rotating fabric media depth filter, a dynamic sand filter or other type of tertiary filter. In the case of the fabric media filter, the effluent traverses a compound pile-type fabric, trapping particulates in the mesh of fine filaments. A cleaning wand periodically washes / cleans the surface of the filter and this particle-rich backwash water is sent to the unit.
- Effluent from the SSR device passes through a UV disinfection unit and into a reclaimed water storage tank.
- Reclaimed water can be pumped to nearby heat pumps in neighbouring commercial buildings for district heating and cooling, and from there to local uses or the reclaimed water transfer line. Additional treatment may be required for specific purposes, for example, low dosage ozonation for applications where exceptional aesthetic characteristics are required.
- The PSR device receives the SSR backwash water and thin slurry from the bioreactor and concentrates the particulates to a thick biomass slurry, which is skimmed off the top of the unit

and combined with primary biomass in the SSR biomass trough. This biomass can then be pumped via progressing cavity pump to the biomass slurry transfer line. Alternatively, the biomass can be further dewatered within the PSR device and accumulated in a bin for periodic collection by truck.

Effluent Quality and Dispersal

The effluent quality described in Figure 17 is a “generic” standard that would meet typical industry standards for most reclaimed water applications. Supplementary treatment may be required for specific sensitive applications.

There are a variety of technologies available for dispersal of secondary or better quality effluent, including:

- trenches or beds filled with gravel or other media (gravity fed or pressure dosed);
- gravelless trenches or beds with chamber systems (gravity fed or pressure dosed);
- at-grade or above-grade (shallow trench, filter bed, mound, capping fill, etc.);
- drip dispersal (subsurface or surface);
- spray dispersal (above ground);
- minimum or zero discharge (evapotranspiration or greenhouse);
- point source discharge into surface water either directly, via exfiltration galleries or via vegetated swales; and
- existing onsite dispersal systems after removal of accumulated wastewater from them.

The advantages of decentralised and hybrid (a mixture of centralised and decentralised) wastewater treatment plant systems are clearly expressed in the summary and conclusions of a recent paper by G.T. Daigger and G.V. Crawford of CH2M Hill:⁴⁴

“Hybrid integrated urban water management systems offer the potential for increased water system security and sustainability for the following reasons:

1. Hybrid systems provide significant water reclamation and reuse opportunities that can be phased in as needed to meet growing water needs caused either by growth of the urban area or a declining water supply resulting from, for example, climate change. In other words, hybrid systems can be the most secure in terms of water supply.
2. Because hybrid systems provide significant water reclamation and reuse opportunities, net per capita water use can be significantly reduced, freeing up water supplies for other uses.

⁴⁴ Crawford, G.V. 2006. Enhancing water system security and sustainability by incorporating centralized and decentralized water reclamation and reuse into urban water management systems. *Journal of Environmental Engineering and Management*, 17(1), 1-10 (2007). 10pp.

3. The net resource consumption for a hybrid system can be less than from a centralized system. This is especially the case when a high level of wastewater treatment is needed for any of the relevant wastewater discharge locations. Resource consumption is reduced because significant pumping costs are avoided, both to distribute reclaimed water and to collect wastewater. Resource consumption for water treatment can also be significantly reduced since only a small portion of the produced water need be treated to and maintained at potable standards throughout a large distribution system.

4. A distributed system is more secure from the perspective of failures and outside intervention. This is because the distributed nature of the water supply system confines any fault or intervention to a small portion of the entire urban area. Likewise, impacts of a disturbance of a component of the water or wastewater treatment system are also confined to a portion of the urban area."

Water recovery opportunities are discussed in *Appendix E: Water Conservation and Recovery*.

Appendix E: Water Conservation and Recovery

Closed-loop Water Systems

From an ecological perspective, IRM and water reuse provide opportunities to create closed-loop water systems with significant ecological benefits. In most urbanised areas, water for human use is diverted from surface water supplies (which are ultimately fed by groundwater) or extracted from groundwater wells in large quantities for commercial and household uses. Rarely is water returned to the groundwater system in volumes that are similar to natural infiltration conditions. Coupled with decreased groundwater recharge due to the expansion of impermeable surfaces in the form of buildings, roads, sidewalks and parking surfaces, many jurisdictions have now been ‘mining’ the groundwater for so long that the water table has dropped to critical levels. Boston is now recharging their groundwater table with treated drinking water to prevent the catastrophic loss of buildings and infrastructure as their city subsides due to depleted groundwater and exposure of supporting pilings. Lincoln County, near Spokane Washington, has studied the feasibility of recharging their depleted groundwater table and dried-up streams and lakes with 44 million US gallons per day of reclaimed treated wastewater. Climate change, which may cause greater weather extremes in most regions of North America, may further exacerbate already critical condition of many aquatic systems.

The situation is similar in much of British Columbia. Many urban streams currently suffer from extreme summer low flows, and subsequent elevated stream temperatures, decreased oxygen levels and fish kills due to urbanisation and water withdrawals. Joseph Creek within the City of Cranbrook (pop. 20,000) is an excellent example of this situation. Joseph Creek supplies the City with part of its drinking water. The creek is impounded by Phillips Reservoir (with a small percentage of flow bypassing the reservoir through a side channel) and then flows out of the reservoir and through the city before discharging into the St. Mary River. The stream regularly experiences very low flows in the summer, often resulting in fish kills. This stream was once one of the most productive westslope cutthroat trout streams in the region- the trophy of many fly fishermen from around the region and around North America. If high-quality treated effluent was available to replenish the groundwater table, and that same effluent was reused to offset the demand that potable water places on the stream, then the stream ecology and fishery could be restored with significant implications for the tourist economy of the region.

In order to create closed-loop water systems, wastewater treatment systems need a mechanism for treated effluent to be dispersed and returned to the hydrologic cycle. While large treatment plants have typically used river, lake or ocean outfalls to deal with effluent, on-site systems have used subsurface dispersal (non-point source discharge). Ecologically, large-scale collection systems disrupt and/or modify the water cycle by transferring large volumes of water from one watershed to another (*i.e.*,

drinking water from a river, discharged into a different watershed or directly to the ocean as wastewater) or from one area of the watershed to another area. This is because economically viable and technologically advanced on-site systems were not available. “For most of the 20th century, onsite wastewater options were limited only to septic systems, so the choice for wastewater management was either sewer or septic.”⁴⁵ This has had unintended economic consequences, as land that is not serviced by municipal sewer system and unsuitable for a septic system cannot be developed and is thus devalued. Rules governing septic systems and sewer capacity are used sometimes as *de facto* zoning tools, mainly because if land is deemed unsuitable for installing a septic system (*i.e.*, no percolation), and a connection to or capacity in a municipal sewer is not available, then no one can build a home or any other structure on it that has potential to generate wastewater.

“Research conducted and field experience obtained over the past several decades indicate that soil and site conditions necessary for treatment and ultimate dispersal of septic tank effluent are not necessary for the treatment and ultimate dispersal of secondary or better quality effluent. Hence we need to look at soil and site conditions in a totally different manner when advanced on-site wastewater systems are considered and soil and plant systems are used mainly for ‘polishing’ secondary or better quality effluent rather than for reduction of organic waste load.”⁴⁶

“Subsurface dispersal of secondary effluent can be achieved in an environmentally sound manner on any buildable site...as long as adequate land area is available for hydraulic assimilation of the secondary or better quality effluent and reduction in nutrient or bacteriological contaminant load.”⁴⁷

Reuse of Water for Surface and Groundwater Recharge

Successful examples of stream flow augmentation with treated wastewater can be found immediately south of BC in Washington State⁴⁸:

- The City of Sequim discharges reclaimed water into Bell Creek, a salmon-bearing system, after aerating the water. Excess class A water is discharged into an existing marine outfall into the strait of Juan de Fuca.
- The LOTT Alliance, consisting of the cities of Lacey, Olympia, Tumwater and northern Thurston County, use 250,000 US gal/d (nearly 1 million L/d) to maintain constructed wetlands and recharge surrounding groundwater. The project is currently being expanded to utilise more water.

⁴⁵ Jantrania, A. R., and M.A. Gross. 2006. Chapter 5: Effluent dispersal and recycling systems. In: Advanced onsite wastewater systems technologies. CRC Press, Taylor and Francis Group. New York. 261 pp.

⁴⁶ Jantrania, A. R., and M.A. Gross. 2006. Chapter 5: Effluent dispersal and recycling systems. In: Advanced onsite wastewater systems technologies. CRC Press, Taylor and Francis Group. New York. 261 pp.

⁴⁷ Jantrania, A. R., and M.A. Gross. 2006. Chapter 5: Effluent dispersal and recycling systems. In: Advanced onsite wastewater systems technologies. CRC Press, Taylor and Francis Group. New York. 261 pp.

⁴⁸ Washington State Department of Ecology. 2000. Water reclamation and reuse. The demonstration projects. Publication Number 00-10-062. 16 pp.

Other examples of “ecological” uses of treated wastewater include:

- North Bay in Mason County, Western Washington (pop. 2,700) is irrigating forests with reclaimed treated wastewater to facilitate tree growth and provide drought resistance and fire protection. Water not used for irrigation is being infiltrated into percolation ponds. In BC, where wildland/urban interface fire is a significant risk, irrigation with reclaimed water may provide an additional protective barrier to communities⁴⁹.

Reduction in Demand for Potable Water

Perhaps the most ecologically important “use” of reclaimed water, is its reuse in any form that takes pressure off of the potable water supply and allows water to remain in the lakes, creeks, and rivers to meet the needs of the aquatic organisms that inhabit them. “Small and decentralised wastewater treatment presents unique opportunities for reuse. The important characteristic that distinguishes this type of wastewater management from larger systems is that there is a much greater potential for the treated wastewater to be generated closer to the potential reuse sites. With currently available technology, the capability exists to produce wastewater at the quality that is appropriate for the specific type of reuse, ranging from irrigation of crops to toilet flushing” (see Table 10: Uses of Reclaimed Water).



Figure 19. Sooke Reservoir. CRD Photo

⁴⁹ Washington State Department of Ecology. 2000. Water reclamation and reuse. The demonstration projects. Publication Number 00-10-062. 16 pp.

Table 10: Uses of Reclaimed Water.⁵⁰

Uses of Reclaimed Water	Class of Reclaimed Water Required			
	A	B	C	D
Irrigation of Non-food Crops				
Trees and fodder, fibre, and seed crops	Yes	Yes	Yes	Yes
Sod, ornamental plants for commercial use, and pasture to which milking cows or goats have access	Yes	Yes	Yes	No
Irrigation of Food Crops				
Spray irrigation – all food crops	Yes	No	No	No
Spray irrigation – food crops which undergo physical or chemical processing sufficient to destroy all pathogenic agents	Yes	Yes	Yes	Yes
Surface irrigation – food crops where there is no reclaimed water contact – with edible portion of crop	Yes	Yes	No	No
Surface irrigation – root crops	Yes	No	No	No
Surface irrigation – orchards and vineyards	Yes	Yes	Yes	Yes
Surface irrigation – food crops which undergo physical or chemical processing sufficient to destroy all pathogenic agents	Yes	Yes	Yes	Yes
Landscape Irrigation				
Restricted access areas (e.g., , cemeteries and freeway landscapes)	Yes	Yes	Yes	No
Open access areas (e.g., , golf courses, parks, playgrounds, schoolyards, and residential landscapes)	Yes	No	No	No
Impoundments				
Landscape impoundments	Yes	Yes	Yes	No
Restricted recreational impoundments	Yes	Yes	No	No
Non-restricted recreational impoundments	Yes	No	No	No

⁵⁰ Washington State Department of Ecology. 2005. Frequently asked questions about reclaimed water use. Document number 05-10-02. 10 pp

Uses of Reclaimed Water	Class of Reclaimed Water Required			
	A	B	C	D
Fish hatchery basins	Yes	Yes	No	No
Decorative fountains	Yes	No	No	No
Commercial				
Flushing of sanitary sewers	Yes	Yes	Yes	Yes
Street sweeping, brush dampening	Yes	Yes	Yes	No
Street washing, spray	Yes	No	No	No
Washing of corporation yards, lots, and sidewalks	Yes	Yes	No	No
Dust control (dampening unpaved roads and other surfaces)	Yes	Yes	Yes	No
Dampening of soil for compaction (at construction sites, landfills, etc.)	Yes	Yes	Yes	No
Water jetting for consolidation of backfill around pipelines	Yes	Yes	Yes	No
Fire fighting and protection – dumping from aircraft	Yes	Yes	Yes	No
Fire hydrants or sprinkler systems in buildings	Yes	No	No	No
Toilet and urinal flushing	Yes	No	No	No
Ship ballast	Yes	Yes	Yes	No
Washing aggregate and making concrete	Yes	Yes	Yes	No
Industrial				
Boiler Feed	Yes	Yes	Yes	No
Cooling – no creation of aerosols or other mist	Yes	Yes	Yes	No
Cooling aerosols or other mist created (e.g., use in cooling towers, forced air evaporation, or spraying)	Yes	No	No	No
Process water – without exposure of workers	Yes	Yes	Yes	No
Process water – with exposure of workers	Yes	No	No	No

Water savings can be significant. Case study examples from other parts of North America include:

- Florida: “Reuse has become an integral part of wastewater management, water resource management, and ecosystem management in Florida. During the past 19 years, Florida has risen to be recognised as a national leader (along with California) in water reuse. Approximately 637 million gallons per day (mgd) of reclaimed water were reused for beneficial purposes in 2004. The total reuse capacity of Florida’s domestic wastewater treatment facilities has gone from 362 mgd in 1986 to 1,273 mgd in 2004 which amounts to an increase of 252 percent. **The current reuse capacity represents about 56 percent of the total permitted domestic wastewater treatment capacity in Florida...** Reclaimed water from these systems was used to irrigate 175,262 residences, 443 golf courses, 508 parks, and 225 schools. Irrigation of these areas accessible to the public represented about 50 percent of the 637 mgd of reclaimed water reused.”⁵¹
- California: “The Irvine Ranch Water District (IRWD), located in Irvine, California, is one of the pioneers in water reclamation through a dual piping system. IRWD operates a tertiary treatment plant and a totally separate distribution system consisting of 245 miles of pipeline, eight storage reservoirs and 12 pump stations for reclaimed water. Reclaimed water now makes up 20 percent of IRWD's total water supply and provides irrigation for 80 percent of all commercial and community landscapes, including parks, schools, golf courses and open space. Over 5,650 acres of landscaping are irrigated with reclaimed water. A few estate-sized residential lots also use the water for irrigation and most water features are filled with reclaimed water. Reclaimed water has also been used in industrial applications. A carpet mill estimates they save from 500,000 to 1 million gallons per day of potable water by using reclaimed water in their production process. In addition to outside use, IRWD has received health department permits for interior use of its reclaimed water. Reclaimed water is currently used for toilet flushing in the district's offices as well as several high-rise office buildings. Potable, or drinking, water demand has dropped by as much as 75 percent in these buildings due to reclaimed water use.”⁵²
- Colorado: At an estimated cost of US\$140 million, Denver Water is currently in the process of building a water recycling system (treatment facility and distribution system) that, upon completion, will be able to treat and deliver up the equivalent of supply to about 34,900 homes. The city of Westminster, Colorado, is operating a reclaimed water facility that at full build-out is anticipated to recover over 3.3 million cubic meters (2,700 acre-feet) from wastewater for local irrigation uses. This represents savings of potable water equal to the amount needed to serve over 2,500 single-family homes for a year. Westminster's reclaimed water customers include Westminster city property, business parks and several golf courses.⁵³

⁵¹ Florida Department of Environmental Protection. 2003. “Water Reuse”. <<http://www.dep.state.fl.us/water/reuse/activity.htm>>. Accessed: September, 2007.

⁵² Crane, D. 2004. Case study in the use of reclaimed water systems: Irvine (Calif.) Ranch Water District. Home Builders’ Association of Metro Denver. <http://www.builtgreen.org/articles/0305e_water.htm>. Accessed: October 31, 2007.

⁵³ Crane, D. 2004. Case study in the use of reclaimed water systems: Irvine (Calif.) Ranch Water District. Home Builders’ Association of Metro Denver. <http://www.builtgreen.org/articles/0305e_water.htm>. Accessed: October 31, 2007.

- Victoria, BC: The University of Victoria (UVic) has successfully piloted the reuse of treated wastewater in BC for toilet flushing in several of the new buildings on campus, including the Engineering and Computer Science building and the Medical Sciences building, saving 4.7 million litres per year of potable water. An innovative heat recovery system from re-circulated wastewater, supplements the ECS Building's heating requirements by 350,000 kWh annually. At present, all new buildings are being dual-plumbed to accept treated wastewater.⁵⁴ UVic also has large green spaces and gardens which are regularly irrigated with potable water. Treated wastewater could be used to replace this potable water, thus lowering demand on the drinking water supply. In addition, an IRM approach at UVic could be further expanded to include use of biogas to supply the university's four existing natural gas heating systems, throughout the campus.

When considering the best use for treated wastewater, the risks and benefits (economic, ecological and social) of each option should be weighed. The selection of options is dependent upon volume, climate, assimilative capacity of receiving waters and soils, and quality of the treated wastewater. In the context of IRM, not only should treatment plants be located such that water could easily be reused or dispersed, but also located such that other resources such as heat, biosolids and energy could also be readily utilised close to source.

The CRD Water Advisory Committee prepared a report⁵⁵ looking at water recycling options, and noted the following conclusions:

- “The Ministry of Health Planning does permit recycling water provided the Code of Practice for the Use of Reclaimed Water under the Municipal Sewage Regulation is followed. Examples are the Sooke Harbour House and the Children and Family Services Building in the Capital Regional District (CRD) and other applications province wide. Hence, there are possibilities to promote and encourage recycling practices in commercial applications to conserve water within the CRD” and
- “In British Columbia, many municipalities reuse water. Okanagan communities such as Vernon, Osoyoos, Oliver, Armstrong and Penticton, as well as Cranbrook and Kamloops practice water reuse. Vernon reclaims 100% of its treated municipal wastewater for irrigating it on 2,500 acres of agriculture, forestry and recreational lands. The annual sewage volume of over 1 billion gallons from a population of 38,000 supplies treated irrigated water during the summer months following advanced treatment, storage and disinfection.”

⁵⁴ University of Victoria. 2006. Sustainability Report 2006. 20 pp.

⁵⁵ Water Advisory Committee, Capital Regional District. April 2003. Recycling Water: A Conservation Strategy for the 21st Century. 48pp.

Water and Climate Change

A study published in October 2007 by the National Academy of Sciences (USA) confirmed that human activities are releasing carbon dioxide faster than ever before, while the natural processes that normally slow its build up in the atmosphere appear to be weakening.⁵⁶ Growth and heavy manufacturing in Asia is increasing faster than predicted and, particularly in China and India, new coal-fired plants are being built at an unforeseen rate. The rates of CO₂ release exceed even the worst case scenarios predicted by the Intergovernmental Panel on Climate Change (IPCC) models in 2002.

CO₂ is normally captured through the process of photosynthesis, either by phytoplankton in the world's oceans and lakes or by terrestrial plants. The ability of the Southern Ocean to take up CO₂ is diminishing, due to changing wind and ocean circulation patterns. More importantly for IRM, on land, where plant growth and soil microbial activity is the major mechanism for drawing carbon dioxide out of the atmosphere, large droughts in mid-latitude regions have reduced the uptake of carbon. In other words, drought dries out soils and inhibits the ability of plants to grow and take up carbon; this in turn may exacerbate global warming which may lead to worsening droughts. If reclaimed water can be used to augment groundwater and surface stream flows, this will create more resilient plant communities, especially riparian zones, and enhance their ability to capture and store CO₂. If the energy from sewage and wet organic waste can be utilised instead of coal, and this technology can be transferred to industrialising countries, then the need for coal-fired energy will be reduced.

Finally, the heat capacity of water is 3500 times that of an equivalent volume of air.⁵⁷ When land is dried out, either through impervious structures or naturally by drought, the air immediately above the ground surface also dries out and no longer moderates the air temperature to the same extent. This is why resort communities in warm climates deploy misters to cool the air for their guests- the water vapour absorbs heat and makes the guests feel cool. Plants naturally release water vapour. The more plants that are maintained on land, the cooler that land will be. Therefore the more water we can reclaim and use to recharge groundwater, recharge streams, irrigate urban forests, and bolster natural ecological processes, the cooler our surroundings will be. This in turn would dramatically reduce conventional cooling costs in buildings and across cities by reducing the "heat island effect". In cities with populations of more than 100,000, peak utility cooling demand increases 1.5% to 2% for every 0.6°C the temperature rises.⁵⁸ It has been estimated that well-placed vegetation around residences and small

⁵⁶ Canadell, J.G., C. Le Quere, M.R. Raupach *et al.* 2007. Contribution to accelerating atmospheric CO₂ growth from economic activity, carbon intensity and efficiency of natural sinks. Proceedings of the National Academy of Sciences. PNAS Early Edition. October 2007. 5 pp.

⁵⁷ Sigenthaler, J. 2004. Modern Hydronic Heating for Residential and Light Commercial Buildings. 2nd Edition. Thomson Delmar Learning.

⁵⁸ U.S., Department of Energy. National Renewable Energy Laboratory. Cooling Our Cities. November 1993. http://www.eren.doe.gov/cities_countries/coolcit.html

commercial buildings can reduce energy consumption typically by 15 to 35%.⁵⁹ The water for this vegetation can be supplied by reclaimed water or rainwater capture in many cases.

⁵⁹ Akbari, H., S. Davis, S. Dorsano *et al.* 1992. *Cooling Our Communities: A Guidebook on Tree Planting and Light-Coloured Surfacing*. Washington D.S. US Environmental Protection Agency. Office of Policy Analysis, Climate Change Division. Stock number 055-000-00371-8 January.

Appendix F: Energy Recovery

There are many ways of recovering energy from sewage and organic solid waste, including esterification of waste oil to biodiesel, gasification of dry organic waste to synthesis gas, and anaerobic digestion of wet organic waste to produce biomethane (methane from biological rather than fossil sources). Methane is a building block molecule from which other fuels such as ethanol can be produced. Although this study only examined the energy value of waste, it is possible that recovered biofuels will have higher value as replacements for petrochemicals rather than as fuel.⁶⁰

In Europe, it is common to burn mixed municipal waste in incinerators equipped with sophisticated pollution controls. The recovered energy is used to produce electricity and heat. A future study could investigate the costs and benefits of using a clean technology such as plasma gasification to handle remaining solid waste streams, and to investigate the costs and benefits of mining existing landfills for energy, metals, and other resources. Apart from the value of recovered resources, reclaiming landfills can help eliminate toxic landfill leachate and return the land to higher-value uses.

Table 11 on page 116 summarises the various components of municipal waste and their potential uses.

Energy Capture: District Heating & Cooling

The energy in sewage can be captured and used for heating and cooling nearby buildings using heat pump technology. Heat pumps operate on the same principle as refrigerators and air conditioners, extracting heat energy from a low temperature source, and making it available in a higher temperature form. Heat pumps are gaining popularity because they can yield four units of heat energy for every unit of electrical energy consumed. Heat pumps normally extract heat from outdoor air, or from ground-source piping.

An advantage of sewage heat pumps is that no ground-source piping is required, further reducing the cost of providing energy in this way. Treated sewage from local treatment plants can be piped to heat pumps which could either be located in an energy provider's facility, or in a commercial building.

Once heat energy is extracted from sewage, the effluent is cold enough to be useful for refrigeration and air conditioning through district cooling networks. Stores and commercial buildings can use this cold water to replace refrigeration and air conditioning equipment, resulting in lower operating and maintenance costs.

⁶⁰ Who Needs Oil? New Scientist, July 7-13, 2007

In cities where sewage treatment is centralised, it becomes a challenge to distribute the heat energy from treated sewage to the potential users of the energy. District heating pipes are more expensive than simple water pipes to carry treated sewage. The IRM strategy used in this study places small, local treatment plants next to clusters of commercial buildings which can use the heat and cold.

It is common to extract energy from sewage in Europe. For example, treated sewage from Stockholm's Henriksdahls treatment plant is piped to the local energy company (Fortum) where heat pumps extract enough energy from the treated sewage to heat 20% of Stockholm's homes, or 80,000 homes in total.⁶¹ Revenues from this heat along with sales of biogas help Stockholm Vatten to offset the cost of treatment to citizens;⁶² tertiary sewage treatment in Stockholm costs approximately \$78 per home per year,⁶³ in contrast to the Canadian average of \$120 per home per year⁶⁴ for secondary sewage treatment without resource recovery. In Stockholm, the energy company is paid twice for the energy extracted through heat pumps: once for the heat energy, and again for the "cold energy" or "coolth".

A number of district energy systems exist in Canada, including biomass-powered heating systems in:⁶⁵

- Trigen, PEI (33 MW) – energy source includes municipal solid waste
- Ajax, Ontario (35 MW)
- Grassy Narrows, Ontario (0.8 MW)
- Ouje-Bougoumou, Quebec (3MW)
- Lonsdale Energy Corporation, North Vancouver (6MW)

Sewage-source heat pumps are gaining acceptance in Canada: sewage heat pumps will heat the Olympic Athlete's Village in Whistler, for example.⁶⁶

Opportunities in the Capital Region

In the case of heat energy from wastewater, the Capital Region has distinct advantages over Sweden. This region produces high volumes of sewage, the sewage is warmer (approximately 17°C in winter in the Capital Region), and winter heating demands are lower. This relatively high temperature favours

⁶¹ Personal communication between Stephen Salter PEng and Dr. Marta Tendaj, Business Development Manager, Stockholm Vatten on October 9, 2006

⁶² Stockholm uses a centralized wastewater treatment approach. This limits the extent of resource recovery options. The proposed model for the Capital Region offers more extensive recovery and revenue opportunities, hence the net revenue forecast in the IRM model is higher.

⁶³ Personal communication between Stephen Salter PEng and Dr. Marta Tendaj, Business Development Manager, Stockholm Vatten, on October 9, 2006

⁶⁴ Approximate cost of treatment to households in Sidney and North Saanich through the CRD's secondary Central Saanich Wastewater Treatment facility

⁶⁵ Arkay, K. and Blais, C., 1999. The District Energy Option in Canada. Community Energy Technologies (CET), CANMET, Natural Resources Canada

⁶⁶ Municipality of Whistler

heat pump energy in two ways: warmer temperatures mean that more energy is available, and the higher temperatures result in a higher Coefficient of Performance for the heat pumps, meaning that more energy is produced per unit of electrical energy consumed.

A difference between Europe and Canada is that European central treatment plants are able to convey treated sewage to a single local energy company, which then extracts the heat by means of heat pumps. The heat is then fed into existing district heating networks. Since Canadian cities have very few district heating and cooling networks, we can use a different strategy: locating the treatment plant next to the energy client. Apart from the advantages of distributed treatment over central treatment outlined elsewhere in the report, this strategy results in a lower cost of implementing IRM; pipes to carry treated effluent to a nearby building are much less expensive than insulated district heating and cooling pipes. The majority of heat recovery would be achieved in the Capital Region with very limited district heating piping, since treatment plants would be located near energy users. As is the case in Europe, district heating and cooling in the Capital Region could gradually be expanded from high-density commercial centres and out into communities of single-family dwellings.

Heat and cold could be provided from treated wastewater in two ways: multiple local district energy systems, and building-based heat pumps.

Multiple Local District Energy Systems

In this option, heat pumps would extract energy from treated wastewater, and deliver the energy to users through a network of insulated water pipes—a district energy system. After heat energy has been removed from treated wastewater, the effluent temperature is near freezing. This cold water can be run through efficient water-to-water heat exchangers to provide chilled water suitable for air conditioning and process cooling. The chilled water would then be distributed through insulated district cooling pipes to nearby buildings. Wherever possible, district energy pipes could be installed in conjunction with roadwork by utilities (water, gas, phone, etc.) in order to reduce cost.

The advantage of this approach is that surplus heat or cold from one building can be carried by the district energy pipes to buildings where it is needed. This approach creates the possibility of a “net metering” system that can allow subscribers to exchange their excess heat and cold with each other.

For example, if a municipal skating arena produces excess heat energy from their ice refrigeration equipment, this heat could be fed to the district heating network for use by a neighbouring office building. If the office building has excess cold energy after extracting heat from treated sewage for example, this cold energy could be sent to the skating arena to lower their cost of maintaining ice. In this way the district cooling and heating networks could operate like a communication network, where the network owner charges a fee to users to send heat or cold to each other. If industrial/commercial space heating and domestic heating/hot water users are connected to the same loop, they will also be able to balance heating and cooling loads between daytime and night demands, further reducing energy consumption and cost. This additional benefit has not been considered in the IRM analysis. *Table 5: Potential District Energy Winter Loads in the Capital Region and Table 6: Potential District Energy Summer Loads in the Capital Region* on pages 33 and 34 show how district heating can offer opportunities for both heating and cooling at different times of year.

Building-based Heat Pumps

In this option, decentralised treatment plants would be located close to an energy client, and the plant could be sized to take into account the client's need for energy. Treated wastewater would be piped to the client's building, where a water-source heat pump would extract heat energy and would simultaneously chill the water to provide cooling through water-to-water heat exchangers.

Apart from the advantages of distributed treatment over central treatment outlined elsewhere in the report, this strategy results in a lower cost of implementing IRM; pipes to carry treated effluent to a nearby building are much less expensive than insulated district heating and cooling pipes. This option reduces the need for expensive district energy piping, since treatment plants would be located near energy user. This option also reduces energy losses through district heating pipes, which carry water at 60–70°C, compared with the much lower temperature of treated wastewater. On the other hand, this approach would require buildings to maintain a certain amount of back-up capacity in the form of conventional heating equipment.

A further advantage of this approach is that once the treated wastewater has passed through the building owner's heat pumps and heat exchangers, it could be used for low-grade water uses such as toilet flushing or irrigation on the property.

District heating can serve most existing buildings which have the following types of systems:

- Hydronic (hot water) heating systems with existing gas or oil-fired boilers
- Forced warm air heating systems, (hydronic coils can be installed in existing ductwork)
- Water-source (California Loop) heat pumps systems
- Domestic hot water loads

District cooling can serve most buildings having the following systems:

- Chillers (common in large buildings).
- Water-source (California Loop) heat pumps systems
- Air-based systems (hydronic coils can be installed in existing ductwork)
- Ice Rinks, supermarkets, and other process refrigeration

District Heating and Cooling Assumptions

The price of district heating energy is set at a 15% discount below the price of energy available from the (currently) lowest cost source, which is natural gas. The model accounts for conversion efficiency of fossil fuels in existing heating plants, to find the real cost of energy as delivered to buildings. The prices paid by heating plant owners for heating oil and electricity is not factored into the IRM model, which means that district heating will present greater savings to owners of heating plants which use oil or electricity than to those who use natural gas.

This study does not deal with ownership of infrastructure, but looks at the revenues and costs from a macroscopic level. In practice, a municipal energy company, a private energy company, or a co-operative of building owners could own the heat pumps, district heating piping, and district cooling piping. The City of Hamilton, Ontario has a municipal energy company, as does the City of North Vancouver (Lonsdale Energy Corporation), and the Quesnel Community and Economic Development Corporation plans to establish a "Municipal Energy and Resource Recovery Corporation" or MERRC.

Although owners of heating and cooling plants will have lower operating and maintenance costs, these savings are not factored into the IRM model.

Typically heat pumps are sized to meet the majority of heating needs for a building, with conventional sources of heating providing back-up and top-up energy for the coldest days. The IRM model assumes this will also be the case for sewage-source heat energy.

The IRM model assumes that all of the available heat energy from treated sewage will be used during the winter heating season, with full uptake five years after the distributed treatment plants are completed. The IRM model assumes that heat pumps will continue to operate at a fraction of their full during the summer months, to provide domestic hot water and cold water for air conditioning.

Flows are not assumed to increase over the life of the project (55 years). This is conservative, since it assumes that aggressive water conservation will be effective. If flows do increase over time, then more energy will be available for heating and cooling.

The Coefficient of Performance (COP) for heat pumps in the IRM model is conservative, since:

- The COP is based on the highest temperature required for heating, which will only be needed on the coldest days. Operators will economise by operating at lower temperatures for the balance of the time, meaning the required heat energy will be provided at lower operating cost.
- Heat pumps can be run in cascade, where the "lift" (the difference between the temperature out and the temperature in) can be halved. When demand for heating energy is lower, the first stage heat pumps could be operated alone, resulting in a significant increase in COP and a significant reduction in electrical energy costs.
- Sewage temperatures will likely be higher with IRM, since distributed wastewater treatment plants will intercept sewage closer to the source, resulting in less dilution by colder infiltrating rainwater. In ideal situation for heat pumps will be to operate from the effluent from a new subdivision, where inflow and infiltration of rainwater is limited.
- Average sewage temperatures in the IRM model will likely increase over time, since the average rate of inflow and infiltration of colder infiltrating rainwater will decrease over time. This improvement is expected to result from the fact that new wastewater loads will come from new developments, and that aging sewer lines will be gradually replaced over time. If regional governments also provide property owners an incentive to divert inflows from downspouts and sump pumps away from sewer lines, the rate of improvement will accelerate.

- Temperatures of effluent from enclosed treatment plants are elevated slightly above the influent temperatures, due to the release of microbial metabolic energy during the treatment process. The IRM model does not take this rise into account.
- If cogeneration can be co-located with heat pumps, it will be possible to use the waste heat to boost the final temperature, allowing the heat pumps to operate at a lower temperature, and thus increasing COP and reducing operating costs.

Benefits from District Heating and Cooling

The IRM model shows that recovering heat and cold from sewage through heat pumps and district heating and cooling networks is profitable. Based on the CRD's sewage flow and temperature data,⁶⁷ the IRM model estimates that 2.2 million GJ/year of heat energy could be provided to buildings in the Capital Region, along with 0.7 million GJ/year of cooling energy. It is expected that the first users of this energy will be commercial buildings and multi-family dwellings.

If the decision to switch from current energy sources to district heating is based on cost, then oil users would have the strongest incentive to switch, followed by electricity users, followed by natural gas users. If the decision is shaped more by an interest in reducing greenhouse gas emissions, then the order would be different, but would depend on the greenhouse gas emission factor for BC electricity. Although the majority of BC's electricity comes from hydroelectric dams, the province is a net importer of electricity from other sources, including fossil-powered generating plants. If we accept that conservation measures would reduce consumption of this marginal, fossil-source of electricity first, then the conservation measure would reduce greenhouse gas emissions at the rate of a fossil-powered plant rather than at the rate of a hydroelectric dam.

Following this logic, if the decision to switch from existing heat energy sources to district heating is based on the need to reduce greenhouse gas emissions, then consumers using electricity for heat should switch first, followed by those using oil, then natural gas. This is because two to three units of fossil fuel are required to produce one unit of electricity because of generation inefficiency and transmission losses. Other benefits of district heating and cooling include the following.

- **Cost savings and revenue potential for building owners:**
 - Lower capital, operating, and maintenance costs as boilers, chimneys, and air conditioning equipment are replaced with simple heat exchangers. (In coastal communities, rooftop chillers in air conditioning systems are typically replaced every 15 years as a result of corrosion,⁶⁸
 - Subscribers can load balance between heating and cooling needs;

⁶⁷ Macaulay and Clover Point Wastewater and Marine Environment Program 2003 Annual Report. Capital Regional District

⁶⁸ Bob Landell, LEED AP, Principal, Avalon Mechanical Consultants Ltd., Victoria.

- Subscribers can exchange their waste heat and cold, further increasing value;
 - Fire insurance costs are reduced as fossil-fired boilers are eliminated; and
 - They are insulated from spikes in energy prices, offered through long-term contracts.
- Revenue potential for energy producers:
 - There is an opportunity to earn a return on investment from capital assets (energy as a service), rather than on the sales of fossil fuels (energy as a commodity); and
 - They are insulated from spikes in supply energy prices.
 - **Jobs:** Producing heating and cooling from local waste streams will create local, sustainable employment. For example in Gothenburg, Sweden (population 500,000) Göteborg Energi employs approximately 1,000 people who manage and maintain waste-to-energy facilities, including district heating and cooling networks.⁶⁹
 - **Noise reduction:** Heating and cooling provided by heat pumps and district heating networks can eliminate rooftop chillers, reducing noise emissions from buildings.
 - **Energy reduction:** District heating and cooling eliminates the electrical energy consumed by refrigeration/HVAC units
 - **Greenhouse gas reduction:** Fossil fuels are replaced, reducing greenhouse gas emissions.
 - **Cleaner air:** Air pollution from heating plants is eliminated.

Challenges Facing District Heating and Cooling

In Sweden, district energy companies like Fortum and Göteborg Energi are focused on increasing their revenues from sales of waste heat. In British Columbia communities, a municipal energy company or other proponent would be needed to market this source of energy.

Building owners will need to be convinced of the benefits of converting to heat pump energy.

Regardless of which approach to district energy is taken, pipes will need to be installed between the decentralised treatment plants and the buildings which will be served by this form of energy.

Heat pumps require electricity, and the cost of this energy has been accounted for in O&M costs in the IRM model. Because of the electrical energy produced through cogeneration, and conserved through the lower energy consumption of distributed treatment, the IRM model shows that more electrical energy will be produced and conserved than will be consumed by heat pumps.

⁶⁹ Personal communication between Stephen Salter PEng and Peter Maksinen, Goteborg Energy on October 5, 2007

Anaerobic Digestion for Biogas

In larger sewage treatment plants, it is common for sludge to be processed in anaerobic digesters to produce biogas, which is a mixture of methane and carbon dioxide. The biogas is normally burned to produce heat and electricity for the plant, thus reducing its overall energy requirement. In Swedish treatment plants, however, it is becoming more common for these digesters to process organic solid waste (often referred to as compostable waste, or kitchen waste) as well in order to produce significantly more biogas. In Stockholm, kitchen waste is delivered not to a landfill but to the Hendriksdals sewage treatment plant, where it is co-treated with sewage sludge to produce enough biogas to run 50 local buses today, a number which will rise to 200 buses by 2010. Landfill needs are reduced, air pollution is reduced, and because the carbon in organic waste comes from the atmosphere, the biogas does not contribute to climate change.

The IRM model is based on operating one or more biogas digesters which will accept sewage sludge as well as all other streams of *wet* organic waste (such as kitchen compost). Anaerobic digesters receive wet organic waste such as sewage sludge and kitchen waste, and rely on methanogenic bacteria to decompose the waste in the absence of oxygen. Although the biochemical reactions in the process are complex, the result is simple: bacteria convert most of the organic carbon in the waste into methane and carbon dioxide. This raw biogas can be upgraded to methane of natural gas pipeline quality, indistinguishable from natural gas. This methane (sometimes referred to as "biomethane") can be fed into natural gas pipelines, or burned in cogeneration plants, buses, or cars.

Biogas digesters are normally incorporated into traditional sewage treatment plants, where the feedstock is limited to sludge from the treatment process. The residual matter from biogas digesters is very high in inorganic materials, since the nutrients are concentrated as organic materials are converted into methane. Although this residue can be composted and used as fertiliser, complications of land application of sludge residues include questions of accumulation of metals and other contaminants in soils. In the IRM model under study, this residual matter is added to dry organic waste (for example wood waste) and processed into a different form of fuel (synthesis gas or syngas) in a gasifier.

Biogas digesters are extremely common in Europe, where they digest sewage sludge, farm waste and manure, food factory waste, and organic solid waste from households. In Sweden, residues from biogas digesters which handle only clean food waste are returned to farmers' fields, where they displace manufactured fertilisers. Residues from sewage plant biogas digesters are used for industrial landscaping. Biogas digesters are becoming more common in Canadian agriculture, and plants are also being developed to handle municipal organic waste.

Methane is a building block molecule, and can be reformed into hydrogen for use in fuel cells. Methane can also be converted into methanol, ethanol and longer-chain hydrocarbons which can be used as transportation fuels or blended with gasoline.⁷⁰ The advantage of this approach is that it avoids the cost

⁷⁰ Taylor, C.E. *Production of Middle Distillates*. U.S. Department of Energy

of converting vehicles to methane, although the economics of the process of producing liquid fuels from methane would need to be investigated.

Opportunities in the Capital Region

In the IRM model, between one and three biogas digesters would be operated in the Capital Region. These digesters would operate in the more efficient thermophilic range rather than the mesophilic temperature range which has been the default in North America. Sludge and organic waste will be pre-treated to increase digester yields by means such as ultrasound, hydrolysis, or high pressure homogenisers. Residues from the biogas digesters would be mixed with the feed stocks for gasification, thus eliminating the environmental, social, and economic issues of landfilling or land application of wastewater biosolids. Biogas digesters could be sited to minimise the distance traveled by collection trucks. With adequate odour control, digesters could be located in the Saanich Peninsula, the West Shore (e.g., Royal Roads University) and the University of Victoria.

Benefits from Biogas

The IRM model assumes that the electricity produced will be sold at the current price offered by BC Hydro for Independent Power Producers (approximately \$0.077 in 2007). No government incentives have been assumed in the model.

The IRM model shows that converting sewage sludge and wet organic waste from the community into methane is profitable. Approximately 980,000 GJ/year of methane could be produced from sewage sludge and wet organic solid waste in the Capital Region. Since the "price" of the feedstock (waste) is stable, the price of the resulting methane need not be directly related to the price of fossil methane.

The biogas digesters could be owned by local governments or by a municipal energy company. The IRM model includes the capital and operating costs of digesters, upgrading equipment, and gas distribution equipment. The IRM model assumes that the methane produced will be sold at a discount, below the price of the equivalent amount of gasoline as an incentive for bus companies and citizens to convert vehicles to methane.

A further advantage of this source of greenhouse gas-neutral fuel is that the supply of organic waste will rise in step with population.

Other benefits not included in the model include:

- **Deferred costs:** There is a value in deferring the potential capital cost of expanding local landfills. In addition, diverting organic waste from landfills contributes significantly to municipal zero-waste policies

- **Potential income:** The landfill could benefit from tipping fees. In Stockholm, the sewage treatment plant is paid a tipping fee for accepting source-separated organic solid waste;⁷¹
- **Jobs:** Collecting and processing wet organic solid waste will create local, sustainable employment. Citizens and businesses would need to be encouraged to participate in source-separation programs, to reduce the cost of processing wet organic solid waste. Source separation in Sweden is encouraged by a two-tier fee for garbage collection, which makes it expensive for homeowners not to separate waste.⁷² Locally, curbside collection of solid organic waste is underway on a pilot basis in View Royal and Oak Bay, with the materials sent for aerobic composting at a facility near Nanaimo.
- **Green energy creation:** Organic waste is diverted from landfills and to methane production.
- **Reduced pollution:** Reduces other forms of pollution, including consumption of land by landfills.

Using methane produced from wet organic waste in buses and cars:

- Displaces fossil fuels and thus reduces greenhouse gas emissions;
- Reduces inner-city noise levels, since methane-powered bus engines are quieter than diesel engines;
- Reduces operating and maintenance costs, since methane-powered engines last longer and require less maintenance; and
- Results in less air pollution, since methane produces less NO_x and particulate emissions than diesel fuel.

Gasification for Syngas

Gasification is the process of decomposing organic solids such as wood waste at high temperatures, with little or no oxygen. Under these conditions, long-chain molecules such as cellulose break down into methane, hydrogen, carbon monoxide, and carbon dioxide. This mixture, called synthesis gas (often abbreviated to “syngas”), is not suitable for storage as transportation fuel, but can be burned for heat or burned in a cogeneration plant to produce electricity and heat. In BC, the Tolko plywood mill near Kamloops has recently installed a gasifier which converts wood waste into syngas, which displaces natural gas in the company's drying operation.⁷³ In July, 2007 Plasco Energy Group completed

⁷¹ Personal communication between Stephen Salter PEng and Dr. Marta Tendaj, Business Development Manager, Stockholm Vatten, on October 9, 2006

⁷² Personal communication between Stephen Salter PEng and Lennart Erfors, Coordinator of Climate Change Strategies, Kristianstad Sweden on October 6, 2006

⁷³ Wood Residue to Fuel. July, 2006. Biomass Magazine.

construction of a 100 tonne per day plasma gasification system in Ottawa which converts mixed municipal solid waste into synthesis gas for electricity and heat production in a cogeneration plant.⁷⁴

Plasma gasification is a clean process with significantly lower emissions than traditional incineration. In California, for example, gasification must meet the requirements of the *California Public Resources Code Section 40117* which includes these requirements: "b) The technology produces no discharges of air contaminants or emissions, including greenhouse gases, as defined in subdivision (g) of Section 42801.1 of the Health and Safety Code. (c) The technology produces no discharges to surface or groundwaters of the state. (d) The technology produces no hazardous waste."

Opportunities in the Capital Region

The IRM model is based on operating one or more gasification plants, which will accept residues from the biogas digesters, as well as all other streams of dry organic waste.

The gasifiers could be owned by local governments, or by a municipal energy company. The IRM model includes the capital and operating costs of gasifiers, as well as the internal combustion engines which would burn this fuel and the electrical generators they would drive.

The IRM model assumes that the electricity produced will be sold at the current price offered by BC Hydro for Independent Power Producers (approximately \$0.077 in 2007). No government incentives have been assumed in the model.

Electricity produced would be sold to the grid, and heat produced would be distributed through district heating. The IRM model shows that the electricity which would be produced from cogeneration/gasification of dry organic waste is more than enough to offset the additional electricity required to run the heat pumps required for district heating.

Benefits

The IRM model shows that converting dry organic waste from the community into syngas to produce heat and electricity is profitable. Dry organic waste could yield approximately 116 GWh/year of electricity, and 390,000 GJ/year of heat energy.

The IRM model assumes an overall conversion efficiency of the energy in synthesis gas to electricity of 35%, which is conservative. In "combined cycle" cogeneration facilities, the hot exhaust from a gas turbine can be used to produce steam for a second stage of power production. The overall efficiency of combined cycle cogeneration can be 50%.⁷⁵ Since the "price" of the feedstock is stable, the price of the resulting energy need not be related to the price of electricity or fossil fuels. A further advantage of this

⁷⁴ Per Siobhan Baker of Plasco Energy Group on November 12, 2007

⁷⁵ Sandvig, E. et al. 2003. Integrated Pyrolysis Combined Cycle Biomass Power System Concept Definition Final Report. US Department of Energy. 109 pages.

source of greenhouse gas-neutral fuel is that the supply of dry organic waste will rise in step with population.

Other potential benefits not included in the model include:

- **Deferred costs:** There is a value in deferring the potential capital cost of expanding local landfills. In addition, diverting organic waste from landfills contributes significantly to municipal zero-waste policies;
- **Potential income:** The landfill could benefit from tipping fees;
- **Jobs:** Collecting and processing dry organic solid waste will create local, sustainable employment. Citizens and businesses would need to be encouraged to participate in source-separation programs, to enhance the supply of dry organic waste;
- **Cleaner air:** Currently, construction waste is incinerated at HighWest Waste Recycler Ltd., located immediately west of Thetis Lake Park.⁷⁶ The incinerator is the largest single source of dioxin emissions in Canada, at 8.082 grams per year in 2006.⁷⁷ In contrast, the 30 municipal waste incinerators in Sweden together emit less than 1 gram of dioxin per year in total. Diverting construction waste away from incinerators, through a sorting process to remove sources of dioxin (e.g., plastics), and gasifying the resulting clean wood waste would have the upstream benefit of reducing air pollution;
- **Greenhouse gas reduction:** Cogeneration to produce electricity and heat from syngas displaces fossil fuels, and thus reduces greenhouse gas emissions (see Appendix G);
- **Energy efficiency:** Local electricity generation avoids transmission losses, thus increasing the efficiency and reducing the environmental impacts of electricity generation.

Recovery of Metals

The residue from gasification is ash, which can take the form of a vitreous solid in which metals are bound and cannot readily leach into the environment. This material has been used as a road base, but could be included with ore for refining by mines. The CTMP pulp mill in Chetwynd, BC produces a similar ash from standard combustion of its waste products. This ash is currently sent to a mine in New Brunswick for refining into metals.⁷⁸

Local governments would need to select the highest and best use for inert residues in this region.

⁷⁶ CRD. Report to the Environment Committee Meeting of Wednesday, 23 May 2007. Report #ESW 07-42.

⁷⁷ National Pollutant Release Inventory, 2006, NPRI ID 7827

⁷⁸ Personal communication between Stephen Salter PEng and Fred Stock, Steam Plant Manager, Tembec, Chetwynd BC, 2006

Table 11: Components of Municipal Waste and Their Potential Uses.

Item	Mass/Year (CRD ⁷⁹ Data)	As a “waste”	As a resource
<p>Organic Solid Waste</p> <p>The volume of wet and dry organic waste available is estimated by from CRD reports of the tonnes of waste received at the Hartland Landfill and CRD waste composition studies.</p> <p>Other volumes of dry organic waste are estimated from other sources, including BC Hydro.</p>	<p>Approx 82,000 tonnes/year of wet organic waste⁸⁰, and 100,000 tonnes/year of dry organic waste</p>	<p>Decomposing organic waste causes methane emissions to atmosphere.</p> <p>Although a fraction of these emissions from Hartland are captured to produce electricity, the balance escape to the atmosphere. One tonne of methane has the same Global Warming Potential as twenty-one tonnes of carbon dioxide.</p>	<p>Wet organic waste can be diverted to a biogas digester to produce methane for vehicles.</p> <p>Dry organic waste can be diverted to gasification to produce electricity.</p>
<p>Water</p>	<p>99.95%</p> <p>38 billion litres/year</p>	<p>A significant <i>indirect</i> impact in the form of the environmental and economic impacts of continually expanding regional water supplies.</p>	<p>Process water Irrigation Creek restoration Aquifer recharging</p>
<p>Oil & Grease</p>	<p>5,000 tonnes/year</p>	<p>A significant <i>indirect</i> impact in the form of the lost opportunity to displace fossil fuels with biofuels derived from oil and grease.</p>	<p>Biodiesel, biomethane for vehicles</p>
<p>Suspended Solids</p> <p>Measured directly as Total Suspended Solids (TSS)</p>	<p>8,000 tonnes/year</p>		<p>Biomethane for vehicles</p>
<p>Dissolved Organic Materials</p> <p>Measured indirectly the amount of oxygen taken up by bacteria which consume this material, through Biological Oxygen Demand (BOD)</p>	<p>8,000 tonnes/year</p>	<p>Potential to deplete oxygen in fresh water bodies.</p>	<p>Biomethane for vehicles</p> <p>Synthesis gas for cogeneration</p>

⁷⁹ CRD. 2003. Macaulay and Clover Point Wastewater and Marine Environment Program 2003 Annual Report.

⁸⁰ Includes volumes of sludge which will be produced by the Capital Region’s wastewater treatment plants when they come on line.

Item	Mass/Year (CRD ⁷⁹ Data)	As a “waste”	As a resource
<p>Dissolved Salts, Minerals</p> <p>For example Ammonia, Phosphorous, Potassium, Calcium, Nitrogen. Some of these materials occur naturally in our water supply, while others derive from commercial processes and human waste.</p>	5,000 tonnes/year	Potential to cause eutrophication of fresh water bodies.	Potential fertilisers, which can displace and reduce the environmental impacts of manufactured fertilisers.
<p>Dissolved Metals</p> <p>For example, Aluminum, Arsenic, Barium, Cadmium, Chromium, Copper, Cyanide, Iron, Lead, Magnesium, Manganese, Mercury, Nickel, Silver, Tin, Zinc. Some of these metals occur naturally in our water supply, while others derive from piping, commercial processes, human waste, and household products.</p>	200 tonnes/year	Contribution to contamination of sea beds and the food chain.	Potential for recovery through gasification of sewage sludge.
<p>Chemicals of Emerging Concern</p> <p>This family of chemicals includes Endocrine Disrupting Compounds (EDCs) such as phthalates from landfill leachate and pharmaceuticals.</p>		<p>Even in minute quantities, these compounds can cause gender changes in marine life.</p> <p>Recent research shows that dilute doses of EDCs are more problematic than concentrated doses, and that trace levels of different EDS can cause synergistic effects which are far more harmful than individual contaminants.</p>	<p>As far as possible, these chemicals must be reduced or eliminated from our environment at source, (for example, by treating leachate from the Hartland Landfill).</p> <p>Treatment must be designed to destroy as many of these chemicals as possible.</p>

Item	Mass/Year (CRD ⁷⁹ Data)	As a “waste”	As a resource
<p>Heat Energy</p> <p>In winter, fresh water comes to homes in Greater Victoria at 7°C⁸¹ but leaves significantly warmer. Even after dilution in the winter with water which infiltrates sewage piping, water at the existing outfalls averages 17°C⁸² during the winter months.</p>	<p>Approximately 2.23 million GJ/year</p>	<p>Limited direct impact, but a significant <i>indirect</i> impact in the form of the lost opportunity to displace fossil fuels used for heating.</p>	<p>District heating and cooling, which can displace fossil fuels used for heating. Benefits include reduced greenhouse gas emissions and reduced air pollution.</p> <p>30% of the Region's homes, or 15% of the region's total building energy requirements.</p>

⁸¹ CRD. 2003. 2002 Annual Overview of Greater Victoria's Drinking Water Quality. 41 pages

⁸² Capital Regional District. 2003. Macaulay and Clover Point Wastewater and Marine Environment Program: 2003 Annual Report. 154pp.

Appendix G: Valuation Methodology

It is important that the method for assessing wastewater solutions meet accepted standards. Considerable effort has thus been taken to determine the appropriate way to assess possible solutions, which this section documents. Notably, methods for assessing wastewater are not only technical, they are business case methods.

Business case analyses tend to follow long-established, traditional principles and for projects of adequate size or complexity will often use some form of discounted cash flow (DCF). However when considering longer cash flows such as are experienced with major public infrastructure, standard financial approaches and methods have to be applied with care. This is mainly because the differing costs, revenues, their timing and related aspects can be disproportionately affected by discounting and growth rates.

The result can affect the choice of technology, project and/or construction, and can fundamentally change the financial conclusion. This can lead to different investment decisions than might otherwise be chosen. As a result many sectors of industry use multiple indicators to inform project decisions. For example in Vancouver the real estate industry will often consider Net Present Value (NPV), as well as Internal Rate of Return (IRR), Cash on Cash, Return on Equity and a wide variety of other metrics for measuring projected performance. BC is not unique in this, most developed investment and development decisions are informed by a variety of indicators.

While financial indicators are suitable for traditional investment and development decisions, they provide less than complete indicators for projects with an appreciable sustainable component. Corporate decisions are gradually moving towards broader analysis and reporting, and standards for reporting climate change and social impact indicators are increasingly being adopted. These are most often known through some form of Corporate Social Responsibility (CSR) reporting. Increasingly these are being reported in corporate accounts.

Most business case models are what might be termed "single recipient" models, in other words they tend to assess the perspective of a single business or enterprise, person, company or entity and how the project affects them. However in the public sector, the concern is not simply with a single entity, but the impacts to others of proposed projects. An example that illustrates this is that development of swampland on America's Gulf Coast is widely thought to have increased damage in New Orleans when Hurricane Katrina hit, so while a developer may have benefited, the broader community suffered loss. This potential loss and risk was clearly not adequately adjusted for in the decision to permit development and inclusion of the broader impacts is increasingly seen as desirable.

In the context of public sector, there is a need to understand the wider context and impacts of a project and restricting analysis to purely economic and financial aspects is widely understood to be too limited. A broader set of considerations need to be made in the business case.

DCFs have not generally been used for this purpose because they are typically seen as single-entity financial models. Also, the framework for evaluating the impacts to multiple parties affected by a project is not highly defined and there are few standards to guide detailed evaluation.

It is thus necessary to consider carefully, what business case methods need to be used to evaluate wastewater management and any potential move towards IRM.

Since readers will come from differing professional backgrounds, greater explanation has been provided on the differences in methods of analysis, their relative merits and reasons to choose specific methods. The explanation has also been somewhat simplified to make it more readable to a general audience.

Background on Standards

This section provides comment and interpretation of the relevance of standards and their choice for analysing sustainable projects such as IRM.

Approaches to business case analysis have arguably expanded more in recent years than historically but for current purposes can be typified as falling into three categories: accounting, valuation and non-financial methods.

Accounting methods have been gradually harmonising worldwide under the International Accounting Standards, administered by the International Accounting Standards Board (IAS" and "IASB" respectively]. North America has been slower to adopt changes to IAS. The main aspect of interest in these changes is a shift towards including value as a consideration in accounting. This is because existing accounting methods, especially within government, are largely based on cost. Government assets are usually deemed "Special Purpose Assets" largely because it is thought that there is no market for the government asset or project and these effectively result in using cost approaches to assessment.

By contrast the valuation professions have always focused on value, with cost methods being of smaller utility. Value is better oriented to assessing markets, however it too has been used in a restricted way, since its focus is tradeable or "market" value. Traditionally, this has questionable validity for government projects [the assumption being that these are not 'market' projects]. Market value also tends to use single-entity methods⁸³ to assess government projects and uses cost, for consistency with accounting standards.

The problem these standards and approaches have for IRM, is that IRM can potentially create revenues. Cost approaches are not well suited for assessing projects with revenues.

⁸³ *i.e.*, a cost analysis from the perspective of the project, not necessarily adjusting for the cost impacts elsewhere in government.

Another factor in accounting standards is that costs and revenues are segregated into different headings in accounts and because of differences in accounting treatment of capital items versus cash flow items, means that a project's overall financial picture may not be easily understood because the costs and cash flow structures may be dispersed across multiple accounts and departments, and the broader public. Segregation of different 'accounts' is less of an issue in valuations.

Within the valuation sector, the International Valuation Standards are administered by the International Valuation Standards Committee (IVS" and "IVSC" respectively), and are supported by 60 countries. Canada and the USA were a significant founding contributor to the standards and in 2006 agreement was reached to finalise harmonisation, which some professions and countries have already undertaken.⁸⁴

Current Canadian standards in common practice are the Canadian Uniform Standards of Professional Appraisal Practice or "CUSPAP" and while they are not formally recognised by Canadian government, they are the prevalent standard. Since CUSPAP is being increasingly harmonised to IVS, IVS can be used as an internationally accepted proxy for current purposes.

IVS is better described as a "process" for determining value. This means that the valuer is required to consider the nature of project being valued and determine the most appropriate approaches to use. Valuation standards thus have the flexibility in principle to adapt to assessing IRM.

Public assets have more than pure financial impacts to society however, and they typically affect multiple *entities*. This is an important distinction because both accounting and valuation models are largely focused on a single entity. Sustainable projects almost always affect multiple entities and therefore, single-entity analysis is more challenging and risks failing to capture the broader business case for government.⁸⁵

The largest problem for accounting and valuation standards is that mainstream standards are dominantly financial and thus, need adapting to handle or document non-financial or poorly quantified aspects of a project.

In recent years therefore, increasing emphasis has been placed on tracking and documenting both financial and non-financial aspects of a project that may affect more than one beneficiary. The province developed models for this, which include multiple account evaluation, sometimes known as multi-criteria analysis, multiple account analysis and so on. These generally have been improved into techniques now known as balanced scorecard, which has been adopted internationally. Examples of this include the Global Reporting Initiative (GRI), which is in effect a reporting standard that tracks corporate reporting on sustainability beyond pure financial reporting. While these methods are increasingly being used, they are not universally adopted or recognised within accounting and valuation sectors, or their standards.

⁸⁴ Some valuation professions exist as part of the accounting professions but their models are more aligned with accounting standards.

⁸⁵ In BC, the concept of the 'single taxpayer' helps. Basically, this concept is that while a project might occur within one ministry's domain, the broader public impact may affect other ministries' jurisdiction. Since all the ministries ultimately are held accountable to and are funded by the taxpayer, the idea is that it is the taxpayer's overall perspective that should be considered.

Frameworks & Processes

Several factors need to be considered in adopting a framework and process for evaluating any solution to wastewater and whether IRM is a possible solution:

- In BC, as noted in the previous section, multiple account evaluation was developed to address the multiple interests that might be impacted by a project. It set out a mechanism to understand, track and evaluate their interests.
- In the 1990's, Triple Bottom Line was suggested⁸⁶ (TBL) where in essence, reporting fell under economic, social and environmental "accounts." This has gained wide acceptance, although it is now realised there are more than three accounts.
- In the context of sustainable development, of which wastewater is part, consideration needs to be given to whether a proposed solution is sustainable. In 1987, the United Nations' Bruntland Commission published "[Our Common Future](#)" which developed the widely accepted definition that sustainable development could be expressed as: "Development that meets the needs of the present without compromising the ability of future generations to meet their own needs." On March 2nd, 2007 the Premier signed the [Vancouver Valuation Accord](#), which also adopted this as a definition for valuation in the context of sustainability.

It may help to summarise how these interrelate:

- There are several possible entities that may be affected by a project ["Entities"];
- Each entity will be affected in different ways, positively or negatively, but the impact may not always be financial. Each type of impact for each entity needs measuring, as these will affect the wider decision to proceed with a project ["Metrics"];
- A project and each entity's metrics can be expressed under several accounts which cover economic, social and environmental impacts;
- Sustainable projects should be measured against the Bruntland definition and other policy measures adopted by affected entities.

Current standards are not yet well adapted to address this. However two documents in particular provide an applicable framework to address major projects and sustainability:

- The Province has adopted the [Capital Asset Management Framework](#) (CAMF) and it is mandated by Treasury Board. While the document is incomplete, it provides a sound, provincially adopted standard for major projects. However CAMF is not specifically oriented to address sustainability issues and is insufficiently granular for current purposes.

⁸⁶ See "[Cannibals with Forks](#)" by [John Elkington](#), New Society Publishers (September 1998).

- Commencing in 1997, the [Royal Institution of Chartered Surveyors](#) worked jointly with the [Environment Agency](#) (an agency of the UK government) resulting in a document titled "Comprehensive Project Appraisal" (CPA). This has significant correlation with CAMF and was developed to address the issue of the environment, society and the broader issues raised by financial and non-financial accounting.

Because CAMF is a provincially adopted policy framework and because CPA has close similarities to CAMF but is better adapted for assessing the broader issues of sustainability, these two documents have been considered most influential in assessing IRM. CPA [and to a lesser extent CAMF] has appreciable overlap with both multiple account evaluation and balanced scorecard approaches, noted in the previous section.

We note that CAMF is designed to provide a process for instilling business case methodologies within the public sector and to shift government procurement towards Public-Private Partnerships (P3s). It is not the primary focus of this study to consider the procurement mechanism for wastewater services and therefore, the business case aspects of CAMF are more relevant. Others will determine how best to procure IRM if this proves viable.

In summary for current purposes, CAMF and CPA provide a structure and process for evaluating technologies. CPA sits within the broader valuation professional structure and was developed by a government environmental agency in conjunction with a profession. CPA provides an international best practice consistent with the province's existing adopted standard, CAMF.

Approaches to Value

It is necessary to explain how various valuation methods are commonly used and why specific approaches are more suitable than others.

The dominant methods for assessing value are the income or investment approach, the cost approach and a subset method of the income approach sometimes called the development method.⁸⁷ All approaches use component inputs that are derived from comparables or estimates and discipline is required to apply these properly:

- The **direct comparison approach** is a principle of identifying evidence of sales, rentals and other incomes flows, adjusting them for their differences from the subject and applying them;
- The **investment approach** is a method where the value of long term revenues streams are valued at today's date using a "present value" method to convert them to current value. Deductions such

⁸⁷ The development approach has more recently been considered part of the investment approach. However there is a distinction between investment and development that is reflected differently in prevalent development models, since the risk of development is arguably better segregated from investment risk than in the typical investment approach DCF. This is especially relevant to Public Private Partnership (P3) modelling.

as acquisition costs and ongoing costs of operations are deducted and the prevalent model used for this is typically the discounted cash flow or "DCF;"

- The **development approach** dominates the real estate development sector. It is generally less sophisticated in modelling than a detailed investment DCF, which deals with an existing investment. But it is generally more sophisticated in handling the pre-investment (*i.e.*, construction) cash flows and risk and often recognises that pre-investment risk is different from long term investment risk and handles them separately. A common tool used is the 'development residual' – which can focus on a specific item like the homeowner taxes required in the long term, to repay the capital investment of a sewage plant or resource recovery;
- The **cost approach** is a concept that the cost of something is its value, or the item would not have been built or purchased in the first place. While a central concept to the accounting profession, it is typically referred to in the valuation profession as a substitute approach when market approaches to valuation cannot be applied. A key distinction of this approach is that it focuses on cost and not value.

The following places these methods in the current context. Traditionally, sewage is considered a cost undertaken by government in the public interest. Accounting treatment typically uses the cost approach as sewers are deemed Special Purpose Assets and valuation standards follow this principle. In short, both accounting and valuation standards have historically used the cost approach and approaches are similar in calculating cost approaches. Basically they total the capital cost, add in other costs such as consulting, engineering, design and other fees, transaction costs and so on. This total is the project cost.

An IRM approach would likely be rejected using a cost approach. For example one project currently under construction in Victoria will cost \$0.80¢/m³ of wastewater effluent, whereas a nearby and recently built traditional municipal works of comparable scale cost \$0.20¢/m³ of wastewater effluent. On a cost approach basis, a sustainable solution is uneconomic.

Once revenue streams are taken into account, the net value changes. Gas can be obtained from sewage and is bought by a gas utility company, paid to the sewage processing plant owner, or sold for gas-powered vehicles at a price roughly equal to the cost of petroleum, which yields a net profit. In addition if sold as petroleum, carbon credits should be available since gas is reducing fossil fuel dependence. Other benefits include water reuse and recycling, which may benefit streams, fish, the fish industry and consumers. The water could be sold for use in business and/or in irrigation. All these will reduce the need for larger watersheds, treatment, pipes etc.

Thus, despite the extra cost, an IRM solution can yield a net profit. The cost approach is insufficient as it does not cope well with benefits received directly or indirectly; it does not address cost avoidance or cost increase or reduction on others' accounts. It does not address market maximisation or non-financial benefits. It is insufficient on its own to inform good decisions.

For current purposes in essence, all four methods have component benefits and a hybrid approach to valuation can be adapted from them, within the CPA/CAMF framework. Comparables for costs and revenues can be estimated for construction and comparable revenue streams or proxies can be used and

combined largely within a development approach. Because the development method is better suited to creation of an income stream and risk segregation, it is the preferred approach.

Implicit within methods of valuation are numerous underlying valuation aspects and principles, certain of which benefit from consideration.

Firstly the **principle of substitution**, which in summary states that someone will only pay \$1 more for a product or service than the next highest purchaser. This is important because it introduces the concept that resource recovery is "worth" almost exactly what the item would have sold to someone else for. In the context of resource recovery, this by extension means that if potable water is currently being used for irrigation, then recycled or reclaimed water is worth nearly the same as the potable water it replaces.

Secondly the **alternative cost of money**, which assumes that investments in products and services for which there is no direct pricing or worth, has cost or revenue equivalents from aspects they replace. A good example is that water used for irrigation has a "cost of money" equivalent, which could be the cost of potable water. This concept is useful because it allows certain unpriced aspects of resource recovery to be accounted for.

Thirdly there is the concept of **worth versus value**. Value can be defined as:⁸⁸

"The estimated amount for which a property should exchange on the date of valuation between a willing buyer and a willing seller in an arm's-length transaction after proper marketing wherein the parties had each acted knowledgeably, prudently and without compulsion."

Worth can be defined as:

"The value of property to a particular investor or class of investors, for identified investment objectives."

While value addresses value "in exchange," worth can include non-financial value, received by multiple parties. Because the worth and value are not well known in North America, they are used interchangeably in this report, but where market value is used, it directly relates to the valuation definition of market value.

In terms of financial indicators used to compare options, several can be used. One of the most common financial indicators is **Net Present Value** or "NPV." This basically brings future costs and revenues to a current date by a process of *discounting*. An NPV is "net" because it deducts any costs: otherwise it is termed a Present Value or "PV." Related indicators are the IRR, MIRR and similar metrics.⁸⁹

⁸⁸ RICS Red Book definitions of value and worth have been used for current purposes. They mirror those in IVS.

⁸⁹ The IRR or Internal Rate of Return, is useful in evaluating the return on investment from all the costs and revenues in a project. As opposed to the NPV which uses a discount rate from equivalents such as bank lending, the IRR is a discount rate such that all the costs and revenues are equal at the start of the project. The rate is "internal" because it is dictated by the project's costs and revenues. The Modified IRR or MIRR was developed MIT to try and offset some of the problems with choices of discount rate and with how costs and

Discounting means that future costs or revenues are less certain than those today and so are reduced by multiplying by a discounting factor. This factor is often the cost of money, so for example \$100 in ten years discounted at provincial bond rate of say 4% per annum, means the value today is \$67.56. Since CRD's projection is for a life cycle assessment to 2065, \$100 in 2065 at 4% is equal to a value of \$10.28 today. This is a significant reduction and makes the choice of growth and discount rate the single most sensitive aspect of a financial analysis, outweighing all other factors.

Discounting is thus susceptible as a single tool for assessing a project. However options used in the financial and real estate sectors include comparing total project costs, undiscounted and uninflated, since these are the actual costs that will be paid by taxpayers at today's values. This works provided all costs and revenues are changing at relatively similar rates but does not work as well if there is accelerated or 'stepped' inflation.

Several indicators have thus been used. The relative merits of these are discussed in the report.

Highest and Best Use & Value

The concept of Highest and Best Use & Value is fundamental to this study. It is a central concept to the valuation profession and in summary it suggests that anything (a property, asset, business, service etc.) will move to its most economically viable possible use, since this yields the net highest value to the land. Examples may help understand the importance of this concept, relevant to the current concept:

- Localisation of sewage treatment may make sense if the resources can be reutilised economically, net of possible cost increases, including ongoing operations and management. By assessing the total benefits of reutilisation and deducting the probable extra costs of localised treatment, produces a net cost or revenue and thus, even if a decentralised system is more expensive to build and maintain, it could be the net least expensive option solely due to the additional revenue offsets from resource recovery;
- If sewage treatment was localised, with localised use of water, but sewage solids were transported for more centralised reuse, the question is whether this makes sense. Transportation is a cost, but different methods of reutilising the solids could more than offset the cost of transporting them. This method would be chosen if the net revenues of centralised gasification, including transport, exceeded the net revenues from localising the gasification. In essence the current CRD model and that used in many BC communities, has concluded that larger plants are more cost effective, despite the extra pipe cost;
- If recovery of biofuels are to be recovered from waste, the next question is which conversion technology should be used.

revenues flow in cash flows. It uses different rates for costs and revenues and flows the costs and revenues differently. While for longer projects it is arguably superior, the MIRR is not in dominant usage.

- Anaerobic digestion of wet solid organic waste (kitchen waste for example) and sewage sludge can produce methane fuel cogeneration of electricity and heat, or to run buses cars. Using methane from a biological source reduces GHGs, and is a long term hedge against petroleum fuel price increases. It has a value approximately equivalent to the price of the petroleum it replaces, which is a significant potential revenue.
- Gasification of dry solid organic waste (wood waste for example) creates fuel only suitable for generating electricity through stationary engines, which results in a loss of energy through conversion. The resultant electrical and heat energy has a lower economic value than methane in vehicles, and a lower GHG benefit since most of BC's electricity comes from cleaner hydroelectric energy. Thus, there is arguably a lower overall value benefit.

The total benefit of each alternative over its life cycle has to be assessed, with the revenue profile for each (energy plus GHG benefit, plus other benefits), from which are deducted both the capital and operating costs. This is a life cycle *valuation*, as opposed to life cycle *costing*, which only costs the item over its life cycle and ignores the potential margins and profits. The analysis has to assess not only the internalised and direct revenues but also the consequent benefits, costs and revenues from the option. The next result is the highest and best use and value of drawing off the energy from solids.

The complexity to highest and best use and value therefore, is that it should ideally be assessed for each of the options in the circumstances it is intended to be used. This is a very complex calculation that goes beyond the current scope and budget, so proxies have been used to some extent.

Carbon Price

Current proposals for carbon markets have focused on a tradeable open market price. Values on the European market fluctuate but during this study showed a price in the range of \$30 per tonne, which was adopted following discussions with provincial government. We subsequently understand that provincial government may be adopting a value in the order of \$25 per tonne.

In December 2007, the UK government issued a paper⁹⁰ seeking expert input and review of a proposal to introduce a "shadow carbon price," with a commencing value in \$2007, of £27.50 per tonne, *i.e.* approximately C\$51 per tonne. The concept behind this appears to include a concern that market carbon pricing may be insufficient to properly reflect environmental impact in government business cases. In January 2008, the UK government mandated a change to include shadow carbon pricing with an annual growth rate of 2%. In addition, the shadow carbon price model correctly differentiates between carbon dioxide and other more harmful gases such as methane.

The steps to the UK's shadow carbon price method and price graph are summarised in Figure 20.

⁹⁰ "[The Social Cost of Carbon & the Shadow Price of Carbon](#)" – HMSO, 2007

- Step 1: Quantify the impact on greenhouse gas emissions** giving the figures in tonnes of carbon dioxide equivalent
- Step 2: Calculate the correct schedule of the Shadow Price of Carbon** to use and set it alongside the quantities of greenhouse gases saved
- Step 3: Multiply each year's quantity of greenhouse gas emissions** abated/emitted (expressed in CO₂e) by that year's Shadow Price of Carbon
- Step 4: Use these monetised greenhouse gas values in your cost-benefit analysis**

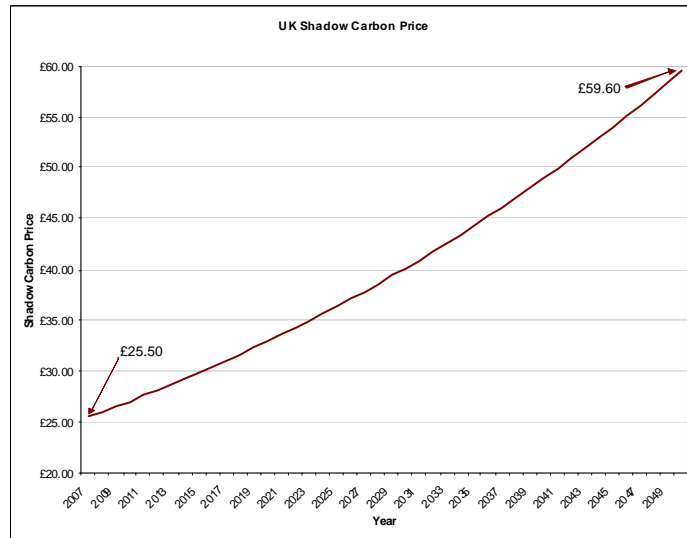

Figure 20: Shadow Price of Carbon

The UK's shadow carbon price model has some similarities to the process adopted for the IRM model and provides a possible direction for the model to evolve; especially, by addressing the GHG impact in terms of carbon dioxide equivalency. The IRM model does not currently distinguish between different types of greenhouse gas: if it were to do so for example, methane gas reduction alone would improve certain IRM revenues by a factor of 21 times the current values.

Following further discussion with provincial government, we concluded that the proposed rate of \$30 per tonne should not change:

- there are few carbon trading investments in British Columbia and therefore, while the opening price on the carbon market may be \$25 per tonne, we were advised that it is probable this value would rise;
- \$30 per tonne is within an acceptable range on carbon markets;
- applying a shadow carbon price to the model would appreciably shift the value in favour of IRM, however government has not yet adopted a shadow carbon price in British Columbia;
- no growth has been allowed for in the IRM model (other than general inflation) and therefore, any potential rise in carbon trading price has for the most part been excluded;
- In the "chosen scenario" a \$5 per tonne change results in a total net present value adjustment in the order of \$68 million. This is not considered highly significant in the context of total capital values exceeding \$1 billion.

Should government adopt something similar to the UK's shadow carbon price for aspects such as major infrastructure and investment decisions, the difference would be more significant. This is presumably

why the UK government decided that shadow carbon prices should be included in all UK government business cases. We did not feel comfortable adopting this

Provincial government may wish to review the UK policy and possibly, adopt a similar policy within government business cases. Using IRM as a model, suggests that while the carbon market price will tend to encourage a more sustainable approach within business cases, the impact of discounting models (DCF-based models and indicators) will tend to "devalue" future benefits to the environment. A shadow carbon price with a built-in growth rate may tend to compensate for these factors.

Should the province decide to include a shadow carbon price in business cases, care must be taken to distinguish such business cases from a "market valuation" approach which uses a carbon value that is tradeable on the exchanges.

After issuing the IRM Final Draft Report in December 2007, the province has announced the introduction of a Carbon Tax. This has some similarities to a shadow carbon price, but initial indications are that it may not include carbon dioxide equivalencies. This means the UK model will likely produce an accelerated shift towards environmental sustainability, relative to that proposed in BC.

Appendix H: Business Case

Overview

Evaluation of Non-financial Aspects

In reviewing the business case for IRM, both financial and non-financial aspects have been evaluated. Financial indicators include non-financial elements because Carbon Credits and fossil fuel offsets have been calculated, thus contributing to addressing the impact of greenhouse gas emissions and impacts.

IRM projects in BC will mostly be driven by local governments, but larger projects will likely include contributions from provincial and federal agencies. It is thus desirable to consider government policy and other aspects at federal, provincial, regional and municipal levels, which have been captured in *Appendix C: Government Policies and Commitments*.

Financial Aspects

IRM was evaluated by constructing a model for Capital Regional District and then extrapolating and relating this for broader use in British Columbia. Individual components for heat, energy, biogas etc. were identified and included in a spreadsheet. Sensitive assumptions have been noted in *Appendix G: Valuation Methodology*. Scenarios were then constructed based on input from the CRD, the IRM Study Technical Advisory Committee, and others.

Financial and non-financial aspects have been generated separately but no bias has been given between these two components. From discussions, it is possible that if the costs are unaffordable then other options will be sought. Conversely, if the IRM solution looks more feasible, it may well be accepted provided it is consistent with policy.

Risk is an aspect considered in most business models. Limitations of time and budget do not permit a more detailed analysis, but preliminary comment has been provided. A preliminary sensitivity analysis assesses financial aspects to gain some understanding of the relative importance and risk associated to assumptions and inputs.

The financial evaluation was less linear than the non-financial review since options for implementing different technologies meant that individual assessment of cost and benefit had to be undertaken. In broad terms the process for evaluation for CRD was as follows:

- Identification of potential IRM options and technologies (desktop review, supplemented by interviews and telephone research, with inspection of an identified technology);
- Preliminary assessment of possible revenue streams and related costs. Cost/revenue gathering to estimate implications for each option, generation of preliminary financial model to estimate highest and best use and value for each option;
- Assessment of the ability to scale plants and equipment to suit local implementations, including estimate of cost, revenue and logistical impacts, capital and operating costs;
- Preliminary highest and best use estimate to understand the optimal mix of treatment, heat and energy recovery, health aspects and so on;
- Initial decision on possible mix of technologies, preliminary assessment of application to specific identified sites within Capital Region;
- More detailed assessment of costs and revenues to the specific models, with extrapolation to more generic (rural, suburban and urban) locations to meet the client brief; and,
- Research on costs and revenues to confirm preliminary financials. Creation of financial model for identified options.

While there have been considerable complexities faced in this initial analysis, we expect that efficiency in using IRM will improve as knowledge increases. However, the complexity and need for an integrated team to optimise the design cannot be overstated. The current study is necessarily limited by available time and budget and is intended as a preliminary assessment of IRM's potential and application in British Columbia. The evaluation is in consequence somewhat restricted and limited, but does provide an understanding of IRM's potential.

Individual municipalities will have to adjust for localised circumstances; for example in northern BC climatic conditions are considerably colder; in BC's Interior, bias towards water conservation may have greater importance and cost, and so on. Since the financial model captures the technical aspects of the solution for Capital Region, this will have to be adjusted to local circumstances.

Several key items have greater impact on the financial model than others and are therefore discussed below:

- **Demand modelling.** Demand projections were reviewed and key factors assessed. Flow projections and consequently, plant sizes are mainly affected by:
 - "Inflow and influent" (I&I), which is largely a result of two key factors; stormwater and sewerage systems that are directed to a single pipe, thus increasing sewage flows ["inflows"]; and increases in flow resulting from cracked and damaged pipes ["influent"];
 - Prior analysis had indicated significant increases in population and this increase had been reflected in influent [*i.e.*, "demand"] projections;

- The extent and cost, and location, of deferred maintenance. This affects I&I and the IRM approach can help reduce the cost of deferred maintenance because it reduces dependence on old pipe infrastructure.

We determined however that a "straight line" increase was unlikely or could be avoided:

- It is reasonable to assume that all new development would separate stormwater from sewage systems and have new pipes. Thus, I&I would be unlikely to increase as a result of a new development. Secondly, it was reasonable to assume that gradual repairs and maintenance to damaged systems would gradually reduce the existing I&I, largely caused by older pipes that will be replaced;
- Capital Region potable water demand has for the last 10 years been maintained at existing levels, despite population increases. Since potable water demand is the largest factor affecting system flows, we concluded that current flows would be contained at current levels. This latter item was discussed with CRD Water and confirmed. Many countries have lower potable water consumption and more aggressive water management strategies than are currently being used in the Capital Region. For modeling purposes we did not assume this;
- IRM is proposed to use a system that will reduce total flows by redirecting the main volumes closer to the source, which is detailed later in this section, by using a "pipe within a pipe" concept and discharging purified water locally, to recharge groundwater. Thus, downstream demand is managed at source so increased flows can be managed locally;
- IRM allows for localised treatment plants to be built as and when needed;
- Since individual IRM plant costs are relatively small, new development can be charged for additional plants and the cost can be managed *without further impact to the taxpayer*. We informally tested this assumption with several developers and found; (a) sewage budgets for infrastructure able to contribute to or cope with the probable plant cost; (b) willingness by medium and larger developers to consider this approach;⁹¹
- We were unable to determine the impact of deferred maintenance for CRD and elsewhere across BC, this item will be important to consider in determining whether IRM is an appropriate solution. Deferred maintenance results in an old system of underground pipes and related pumps and other systems, which leak and reduce the system's effectiveness, until they are replaced.

The high degree of I&I especially in some locations such as Oak Bay, is an indicator of the extent of deferred maintenance. An advantage of IRM it is that it can reduce the expense of replacing existing underground infrastructure. This is because small treatment and water purification plants can be localised close to the source of sewage, and retrofit transmission pipes inserted into existing pipes. By comparison, a regionalised system will require replacement of major collection and transmission pipework, increasing the cost and necessitating larger investment in the old infrastructure.

⁹¹ Note that per capita projected costs for plant and equipment are roughly similar to those for a lift station and associated extra piping and infrastructure. Thus, there are cost savings in an IRM approach that mean developers' cost differential should not be appreciable. This is why those developers approached were willing to consider this approach. Note also that some form of cost/tax transfer may need to be considered to apportion the costs and benefits.

In short, IRM provides a cost avoidance and mitigation strategy, however this has not been taken into account in the current model. CRD municipalities and the others across British Columbia will wish to consider IRM as a possible solution to deferred maintenance issues.

The implication of the above is that, despite population increases, long-term system flows are expected to be reasonably stable in terms of volume but with the increasing proportions of solids. This will increase the efficiency of resource recovery and revenues from resources, but means that IRM's more incremental approach will tend to limit plant and equipment increases. Compared to a traditional approach, an IRM approach means the regional plants do not have to be sized for projected future demand. This lowers initial construction and cost, reduces debt finance and debt carry, and mitigates the risk of projections being wrong.

The impact of this re-analysis of demand relative to a "straight line" increase linked to population is illustrated by Table 12.

Table 12: Demand, Influent & Population Analysis

Base Scenario									
Population trends - CRD					Maximum flow rate				
	Macaulay Point	Clover Point	Total CRD	Growth rate	Sewage flow	Potable demand	Reuse Reduction	I&I	Sewage+I&I
2005	163,000	165,000	328,000	1.35%	0.32m3/person/day	100%	0%	210,000m3/day	315,000m3/day
2015	199,000	176,000	375,000	1.15%	0.32m3/person/day	100%	0%	210,000m3/day	330,046m3/day
2030	253,000	192,000	445,000	0.99%	0.32m3/person/day	100%	0%	210,000m3/day	352,454m3/day
2045	307,000	209,000	516,000	0.84%	0.32m3/person/day	100%	0%	210,000m3/day	375,183m3/day
2065	379,000	231,000	610,000		0.32m3/person/day	100%	0%	210,000m3/day	405,274m3/day

Managed Scenario									
Population trends - CRD					Maximum flow rate				
	Macaulay Point	Clover Point	Total CRD	Growth rate	Sewage flow	Potable demand	Reuse Reduction	I&I	Sewage+I&I
2005	163,000	165,000	328,000	1.35%	0.32m3/person/day	100%	0%	210,000m3/day	315,000m3/day
2015	199,000	176,000	375,000	1.15%	0.32m3/person/day	85%	5%	210,000m3/day	306,937m3/day
2030	253,000	192,000	445,000	0.99%	0.32m3/person/day	60%	10%	210,000m3/day	286,925m3/day
2045	307,000	209,000	516,000	0.84%	0.32m3/person/day	60%	10%	210,000m3/day	299,199m3/day
2065	379,000	231,000	610,000		0.32m3/person/day	60%	10%	210,000m3/day	315,448m3/day

- Fossil Fuel Trends.** Traditional sewage systems do not generally have regard to the alternative cost of fuels since these do not affect traditional business cases, however an IRM approach requires this to be considered because recovery from heat and biogas are expected to replace fuel for oil and gas fired boilers. In consequence, IRM would reduce the number of vehicles on the road using petroleum as an energy source, and replace commercial and potentially residential heating and cooling sources. Since fuel price rises exceed the general trend of inflation, we have thus assessed the impact of this potential revenue source.

Statistics Canada data on historic fuel price trends for Vancouver and Victoria have been analysed. The trends are shown in *Figure 21: Energy Price Trends, 1990-2007* on page 134.

Figure 21 shows fuel price rises slowly trending upwards, but with accelerated inflation starting in about 2000. It highlights the accelerating trend with the exception of electricity which in BC, has remained fairly stable due to generation from hydro-electric sources. A more accurate hydro-electric analysis is to use the marginal rate of energy since BC Hydro is purchasing electricity at high marginal rates from carbon-intensive sources, until more sustainable sources can be brought on line, which is Hydro's and government's intention.

The average trends from the last 17, 10 and five years were reviewed for heating oil and gas. Averages tend to incorrectly reflect the underlying trend. Since IRM generates appreciable biofuels, electricity and heat, this means that additional growth must be applied to reflect the higher increases in energy, over and above the general level of inflation.

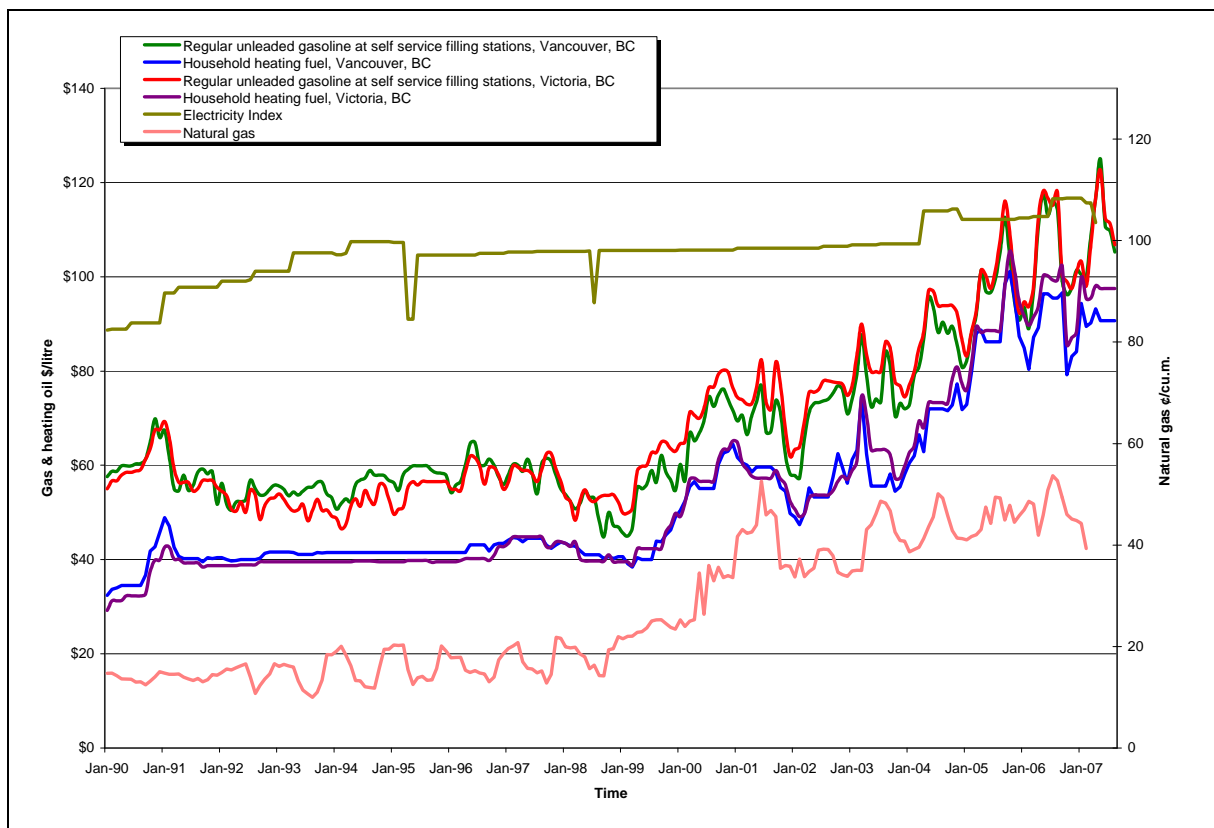

Figure 21: Energy Price Trends, 1990-2007

Table 13: Average Fuel Price Trend Projections

	Average fuel inflation rate	General inflation	Real fuel inflation rate
Home heating fuel	8.06%	1.90%	6.16%
Gas at the pump	4.73%	1.90%	2.83%
Natural gas	4.66%	1.90%	2.76%

In the model, a variety of real inflation⁹² trends were assessed and BC Hydro approached to understand the rates that might be most appropriate. While more work needs to be undertaken on this aspect than could be coped with in the current study, we concluded that a base minimum would be to assume that long term trends would be at the same rate as inflation, *i.e.* no growth in real terms. This was used for 'chosen' and 'pessimistic' scenarios. For the 'optimistic' scenario, we used the above table.

The scenario analysis illustrates the importance of clarifying this assumption: whether IRM is undertaken by the private sector or by municipalities, accurately estimating possible energy trends will appreciably affect the model. This will be increasingly important as energy prices rise due to Peak Oil, depletion of natural gas resources and so on, in essence a potential windfall benefit to whoever controls IRM, and potentially an economic competitive benefit for CRD and BC, since residents should be buffered against energy prices and supply fluctuation such as experienced following hurricane Katrina.

Paying for Sewage Treatment

The general public are usually unaware of wastewater treatment until something goes wrong, creating an unpleasant smell, often caused by leaking pipes or malfunctioning treatment plants that are open to the air. The cost of sewage treatment is typically a small portion of annual taxes because the treatment plant and pipes are usually old and have long since been paid for. Thus, annual sewage taxes have more to do with the ongoing operations and maintenance than payment to replace aging infrastructure with new plants and equipment.

Creation or replacement of sewage systems can thus cause potentially large increases in tax since the capital cost has to be paid for. As a result, the type of treatment plant becomes a sensitive issue because it can significantly affect the contributions sought from the general taxpayer. This is one reason to consider a different way to deliver sewage treatment. One option is to use a fairly traditional system, but increasingly an alternative is to switch to an integrated system where the waste resources are recovered to provide revenue and reduce the environmental impact.

In the face of rising energy costs, the question is: how can treatment become as cost-efficient and energy-efficient as possible? Research suggests that sewage contains 9.3 times the energy required to

⁹² The "real fuel inflation rate" is an annual rate for fuel price rises, adjusted for the general level of inflation.

treat it.⁹³ How can we move toward this ideal, and recover energy from waste? The Integrated Resource Management [IRM] model incorporates the means to recover as much energy as possible from sewage and other waste streams, in order to make waste pay its own way. In this context: The IRM analysis does not include grants or subsidies, although it meets the eligibility criteria of a number of funding programs; The model does not take into account cost savings which could potentially be realised through normal prudent management. These vary depending on the scenario; the model contains many elements that could vary and a full risk analysis has not been undertaken at this stage. Offsetting these positive factors are balancing negative factors.

Process & Principles Used

It is important to use accepted standards in evaluating IRM. Although a more complete summary of the methodology used is included in *Appendix G: Valuation Methodology* (page 119), the following summarises the approach used in this study.

The methodology used is similar to that common in the business sector. For example this method is in common use by real estate pension funds and developers, but for our purposes has been modified to include environmental and policy components that would have to be considered by government.

Government typically follows fairly standard ways of assessing a major project. Usually, technical specialists assess the demand for a service, and devise one or more possible options, with associated outline specifications. This provides some assurance that appropriate quality, timeliness, operation and other criteria will be met.

The options will usually be assessed against criteria established for the project, which include technical criteria, budget, service and so on. Policy and other aspects will help define the probable preferred option. The preferred specifications are then priced, and the cost typically goes through a "value engineering" process to reduce the cost. Depending on how the project will be delivered, more work will be undertaken to refine the preferred model and either the specification will go out for tender, or government will seek bids to provide the service.

The model used varied this only slightly, to suit the circumstances and application. Instead of using cost as a key driver, net value was used as the primary financial indicator. This means that while cost was evaluated, so also were all the possible revenue sources including value to the taxpayer, for the main possible options. The difference between the total value and total cost [the 'profit'] was used to determine the optimal model for CRD, and to assess how IRM could be applied in the broader context of the province. This subtle difference from typical methods of analysis created a significantly different approach and conclusion.

⁹³ Shizas and Bagley. Experimental Determination of Energy Content of Unknown Organics in Municipal Wastewater Streams. *Journal of Energy Engineering*, Vol. 130, No. 2, August 1, 2004

The process of using value with other factors as the leading determinant for direction follows a best practice developed by the UK Ministry of the Environment ["the environment agency"] in conjunction with the Royal Institution of Chartered Surveyors, which is the world's largest real estate professional body. Termed "Comprehensive Project Appraisal" (CPA), the process was developed to address government projects where there is an environmental component, and is compliant with international valuations standards. It is also closely similar to the provincial Capital Asset Management Framework (CAMF), mandated for projects of this type. Thus, we have followed international valuation standards and practices and are consistent with provincial standards.

Financial Analysis

Financial conclusion tables have been provided in both of the executive summary and conclusions sections of this report. These include notes and explanations and the reader is therefore referred to the *Capital Region Business Case Summary* on page 37 for more information. This section provides additional explanatory notes on the financial analysis.

The financial analysis has been integrated with technical evaluation and performance measurement. While this added complexity to the task of integrating financial and technical analyses, it greatly facilitated optimising the IRM model. Comments on key financial aspects are as follows.

Observations on Methodology

- In the time available, it was not possible to construct a detailed discounted cash flow. Instead, the analysis relied on discounting formulae either created in Microsoft Excel or using Microsoft Excel's own embedded formulae;
- Averaging methods were used for life cycle cash flow calculation. For example, a building interest weighting half period was adopted for several of the calculations, which mathematically emulates more detailed monthly or annual cash flows. It will likely underestimate the value of the revenue profile for many of the resource recovery revenues, since fairly conservative real growth rates were adopted;
- More work is desirable to refine assumptions as to the speed of implementation and receipt of revenues. At this preliminary level of analysis, we made several fairly conservative assumptions that with proactive management could be exceeded. This would logically form part of later and more detailed modeling, should IRM be concluded a suitable approach to wastewater treatment;
- Overall, we expect the financial simplifications to average themselves out. In addition, the high profitability of IRM provides a more than adequate margin for such averaging.

Costs and Revenues

The model used to develop projections and analysis for each of the cost and revenues is extensive and has not been included in this report. A copy has been made available to the province of British Columbia and the model was explained and shown to the Technical Advisory Committee. An explanation of the process used in developing the model is desirable.

Sources for each input item for costs and revenues were identified and validated. For key items, multiple checks were undertaken using different comparators, to confirm the costs of similar items. Depending on the nature of item and certainty of data, median numbers were adopted. With more sensitive costs and revenues, the Team usually determined costs on the more expensive side of the median level and on the less optimistic side of revenues. Items such as finance, contingency and soft costs were segregated as much as possible and kept separate, to avoid the possibility of compounding errors and to make risky items more explicit (these items typically carried heavier contingencies).

Consistent with professional requirements, the Team has retained information documenting how the model was developed and sources of data, some of which was obtained confidentially and has thus been retained in confidence. However since the key item of concern and one of the largest items in the analysis is the localised treatment facilities (Water and Energy Recovery Cell or "WERC"), this is explained below.

Scoping level cost estimates of capital and O&M costs for WERC facilities were determined using two methods.

- Method 1 relies on a comprehensive survey of wastewater plant capital and operating costs compiled by Dayton and Knight Ltd. for the Ministry of Environment of BC as a Technical Assistance Report (TAR) last updated in 2000. This report generated cost curves for construction and O&M versus capacity for several levels of effluent treatment, based on actual cost reports from municipal WWTPs recently constructed in BC. This method has the advantage of specifically reflecting BC cost experience, however, the age of the data means that newer technology is not reflected and requires a hefty price index adjustment.
- Method 2 is a more generic, national method developed by the Canadian Council of Ministers of the Environment (CCME) in 2006 and published on the web at <http://www.ccme.ca/publications>. This method generates cost estimates for municipal WWTPs based on capacity of population served, type of treatment technology, and level of treatment, urban/rural setting and area of the country. As such, it reflects more recent experience and technology, however, it relies on simple algorithms and although it incorporates a location adjustment, it does not specifically reflect BC experience.

The estimates are presented in *Table 14: WERC Cost Analysis*, below.

Table 14: WERC Cost Analysis

Plant Size		Small	Medium	Large	X-Large	Total all plants
Nominal Capacity	m3/day	2000	5000	10000	20000	
Number of Plant of this size		28	2	1	1	32
Aggregate Capacity - Size Category	m3/day	55000	12500	12500	25000	105000
Extra Capacity for Redundancy	%	25%	25%	25%	25%	
Built Capacity	m3/day	2500	6250	12500	25000	
Equivalent Population Served per plant	persons	7500	18750	37500	75000	
Peaking factors - screening		500%	500%	500%	500%	
Peaking factors - prim, sec, tert		200%	200%	200%	200%	
Peaking factors - prim, sec, tert (incl EQ)		400%	400%	400%	400%	
Capital Costs						
<i>Method 1: Historical Costs BC WWTPs</i>						
Adjusted flowrate Basis	m3/day	3405	8512.5	17025	34050	
Cost Read from Cost Curves	\$ millions	5.5	11.2	20.1	35.3	
ENR Basis		6223	6223	6223	6223	
Current ENR		8050	8050	8050	8050	
ENR Factor		1.3	1.3	1.3	1.3	
Escalated Construction Cost (ECC)	\$ millions	7.1	14.5	26.0	45.7	
Extra Redundancy Cost factor	5%	0.4	0.7	1.3	2.3	
Special Odour, Earthquake, Noise	15%	1.1	2.2	3.9	6.9	
Allowance for Special Architecture	15%	1.1	2.2	3.9	6.9	
Total Construction Cost (TCC)	\$ millions	9.5	19.6	35.2	61.7	
Engineering	13%	1.2	2.5	4.4	7.7	
Total Capital Cost (excl land)	\$ millions	10.7	22.1	39.6	69.4	448
<i>Method 2: CCME Method 2006</i>						
Base estimate from CCME calculator	\$ millions	7.1	12.9	20.5	35.6	
Contingency	20%	1.4	2.6	4.1	7.1	
Location Factor	10%	0.7	1.3	2.0	3.6	
Final CCME estimate	\$ millions	9.2	16.8	26.6	46.3	
Escalated Construction Cost (ECC)	\$ millions	9.2	16.8	26.6	46.3	
Extra Redundancy Cost factor	5%	0.5	0.8	1.3	2.3	
Special Odour, Earthquake, Noise	10%	0.9	1.7	2.7	4.6	
Allowance for Special Architecture	15%	1.4	2.5	4.0	6.9	
Total Capital Cost (excl land)	\$ millions	12.0	21.9	34.6	60.2	469
O&M Costs						
<i>Method 1: Historical Costs BC WWTPs</i>						
Cost Read from Cost Curves	\$ millions	0.27	0.44	0.74	1.24	
ENR-adjusted Costs		0.43	0.71	1.19	2.00	
Credit for Energy Efficiency		0.01	0.04	0.03	0.03	
Credit for Process Simplicity and Shared Ops	20%	0.09	0.14	0.24	0.40	
Total Annual O&M Cost		0.33	0.53	0.92	1.57	12.7
<i>Method 2: CCME Costing Template 2006</i>						
Base estimate from CCME calculator		0.40	0.71	1.13	2.00	
Credit for Process Simplicity and Shared Ops	20%	0.08	0.14	0.23	0.40	
Total Annual O&M Cost		0.32	0.57	0.90	1.60	12.4

Some notes regarding interpretation of Table 14:

- a) Each plant has a 25% extra capacity for redundancy and this larger size is reflected in the estimates.
- b) Peaking factors are easily misinterpreted. Major equipment in the plants are designed to handle 400% (screens) or 200% (balance of equipment) on an instantaneous flow basis. The plants also incorporate equalization tankage so that the primary, secondary and tertiary equipment can handle influent flows up to 400% of average for periods of several hours. It is assumed that peaking conditions worse than this would be dealt with by collection system remediation.
- c) Method 1 required an adjustment to the flow basis because of differences between CRD per capita flows and those assumed in the method.
- d) Allowances have been made for special configuration and construction circumstances for WERC installations, as listed in the table. It could be argued that the Method 2 allowances should be less because of the fact that Method 2 reflects newer technology, however, in this instance the same factors are used for both methods.
- e) Method 1 estimates are escalated using the appropriate ENR indices.
- f) With regard to O&M costs, under both methods, a credit is claimed for the fact that many similar, networked plants, as in the case of WERCs, will be less expensive to operate and maintain than standalone plants. For Method 1 a credit is also claimed for improved energy efficiency. This claim is not made for Method 2, which presumably reflects more recent efficiency improvements.

In summary, the Capital and Operating Cost estimates from the two methods are in reasonable agreement. Method 2 shows stronger economies of scale function, with the smaller plants being more expensive and the larger plants being less expensive, compared to the Method 1 estimates. It should be noted that the relatively good agreement between estimates does not change the fact that these are scoping level estimates and variations in the range of +/- 25% should be anticipated.

Financial Conclusions

It appears that IRM will lead to positive net revenues in most scenarios. Although it will require significant capital investment to yield the projected revenues, and it will also require political commitments and public goodwill to recover the resources and utilise them properly, the conclusions demonstrate IRM to be a viable government business, whether undertaken by government or procured via the private sector.

Certain aspects of IRM will require investment in infrastructure. Procurement of this and management/ownership issues fall outside the mandate of the study, but government will need to consider the financial implications of the collection and transmission portions of IRM infrastructure.

Under IRM, collection nodes will move upstream from current junctions of collection and transmission systems, and consideration will be required as to who finances, undertakes and owns the collection, separation, purification and transmission plant and equipment. Depending on these considerations, government capital investment decisions will change.

In our analysis we included infrastructure costs and associated revenues. Should government decide to procure the infrastructure from the private sector, we expect that both cost and revenue projections will be further refined.

Environmental Analysis

These have mostly been addressed in the main body of this report, however further summary is provided below.

In terms of greenhouse gases, the potential for IRM to help achieve GHG targets was unexpected. This will largely be dependent the following:

- Creating the neighbourhood heating loops and discounting the price of heat so it is guaranteed to be taken up by consumers. A discount from current prices has been assumed in the model to attract consumers away from their existing heating plant: advise us that chillers, for example, are typically replaced roughly every 15 years. A "graduated absorption" increase in revenues has been assumed commensurate with this changeover, although we consider it likely to be faster since savings in plant operations, maintenance and the ability to sell surplus heat back into the grid, combined with the IRM providing a superior buffer to energy fluctuations will in our opinion make the IRM approach extremely attractive. In addition the provincial government has announced a commitment to introduce legislation to make public institutions a carbon neutral by 2010. This policy should expedite the take up of renewable energy sources from IRM across the province. Lastly in this regard, IRM heat can be sold as a green alternative that helps companies meet their Corporate Social Responsibility (CSR) commitments.
- We have assumed it will be possible to place biogas generation and distribution in central locations where it can be used by and is accessible to vehicle fleet users such as BC Transit and commercial taxi and truck fleet vehicles. Government has some control over this but again, we have assumed a gradual take up and discount in order to attract consumers to change, and have not adjusted the discount rate in the model, so that consumers stay with the biogas alternative. In practice however it should be possible to reduce the discount over time. This is not been assumed.

Social Analysis

Almost any sewage treatment solution is likely to be met with scepticism, especially if it is localised to existing neighbourhoods. Generally the concern will be with potential disturbance and odour, however

the model concept for IRM would replace or "twin" existing pump stations and thus be as invisible as current pump stations.

The Study Team reviewed the model and considered whether further improvements could be made to improve the potential for public acceptance. On balance we concluded that communication of the added advantages in reducing odour, leakage and malfunction potential, combined with faster implementation and significant benefits to the environment would make IRM more acceptable. The final compelling reason that IRM would appear superior and achieve public acceptance is the substantial financial benefit in reducing taxpayer burden. We feel this last reason would make IRM a superior and compelling solution compared to other potential alternatives.

Sensitivity Analysis

At draft reporting stage, an analysis of the main aspects driving the project was undertaken. Key items in the model were identified and their values are varied by 10% to calculate the impact on the net present value and total cash, as noted in *Table 15: Sensitivity Table*.

Table 15: Sensitivity Table

Item	NPV Sensitivity	Total Cash Sensitivity
Input Variables - Revenues		
Purchase price of electricity (\$/kWh)	0.40%	0.34%
Selling price of "green" electricity (\$/kWh)	0.21%	0.18%
Price of natural gas (\$/GJ)	6.88%	5.93%
Price of natural gas, after accounting for efficiency (\$/GJ)	6.88%	5.93%
Price of heating oil (\$/GJ)	4.35%	3.76%
Price of heating oil, after efficiency is factored in (\$/GJ)	4.35%	3.76%
Discount of district heating below the blended price of heating	2.04%	1.76%
Retail price of green vehicle fuel (\$/litre)	2.55%	2.20%
Discount of vehicle fuel below the current price	0.64%	0.55%
Price of reclaimed water (\$/m3)	0.11%	0.24%
Value of Kyoto credits (per tonne)	0.87%	0.75%
Input Variables - Financials		
Real Discount Rate	6.81%	0.00%
General Inflation Rate	5.81%	5.35%
Inflation Rate for Electricity	0.05%	0.04%
Inflation Rate for Vehicle Fuel	3.43%	2.96%
Inflation Rate for Heating Fuel	10.06%	8.68%
Inflation Rate for Natural Gas	9.11%	7.86%
MFA Financing Rate	2.00%	0.94%
Annual Construction Inflation Rate	0.53%	0.25%
Amortization Period	1.83%	0.56%
Project Start	16.18%	21.95%
Project End	18.10%	25.91%
General Construction Contingency	0.41%	0.19%
Input Variables - Costs		
Total Capital Costs	3.13%	1.17%
Input Variables - Physical		
%Methane content of raw biogas	2.63%	2.27%
Cogeneration efficiency	0.29%	0.24%
Winter sewage flow rate, October-March (m3/day)	5.45%	4.73%
Annual sewage flow rate (m3/day)	4.93%	4.42%
Average winter sewage temperature, October-March [C]	6.38%	5.54%
Average summer sewage temperature, April-September [C]	5.49%	4.73%
Mechanical efficiency of heat pumps	2.31%	2.00%
Percentage of available summer energy used for domestic hot water	4.93%	4.25%
Ratio of demand for cold vs. demand for heat	0.03%	0.05%
Percentage of water reclaimed	0.00%	0.17%
Kilometres of heating network required	0.39%	0.22%

- The most sensitive variables relate to project timing since this affects construction cost inflation and discount calculations. Project timing is not addressed in this study.
- Less sensitive but important variables are relating to energy prices. This underscores the importance of a shift to resource recovery, and also makes it essential that the input data is legitimate. The input data were derived from government sources or major corporations such as Terasen. Additionally, the model assumed a 15% deduction from energy values, and took an average growth rate provided by Statistics Canada. Bus, while these items are considered sensitive, the sources for the data are considered to be the best available.
- Sewage temperature has an appreciable impact on calculations. This data was provided by CRD and is consistent with temperatures in other locations. It is considered correct.
- Other variables have smaller impact on the overall model than have been tracked in this sensitivity analysis. Other assumptions such as heat recovery efficiencies, etc. Are based on industry standard ratios or have been applied from proven examples, qualifying research and so on. These have not been tracked in the sensitivity analysis but would have an impact on overall conclusions.

In conclusion, while certain aspects of the model are indeed sensitive, they have been reviewed and supported from legitimate and qualified sources. Given the relative sensitivities shown in the table, effort has been placed in supporting appropriate input variables to mitigate the potential for error harming the analysis.

Scenario Analysis

Following the preliminary sensitivity analysis noted above, scenarios were run with input from the CRD, the IRM Study Technical Advisory Committee (TAC) and others. The results are summarised in *Table 8: Financial Summary, Capital Region IRM* on page 38 and graphed in *Figure 14: Capital Region Financial Summary Graphs* on page 39.

This type of scenario modelling is more modest than a more sophisticated Monte Carlo or other assessment of the project however it is considered to provide a preliminary indication of the IRM model's robustness.

The detailed analysis is included in *Table 16: Preliminary Scenario Analysis, Capital Region* on page 145, following.

Table 16: Preliminary Scenario Analysis, Capital Region

Scenario financial summary	Chosen Values	Optimistic Values	Pessimistic Values
Annual Revenues	\$114,000,000	\$436,000,000	\$60,000,000
Annual Costs	-\$53,000,000	-\$50,000,000	-\$54,000,000
Net Revenues	\$61,000,000	\$386,000,000	\$5,000,000
Projection to end (yr)	2065	2065	2065
Total NPV, IRM, stabilised	\$505,000,000	\$6,334,000,000	-\$244,000,000
Total Value (cost), stabilised, undiscounted	\$3,053,000,000	\$18,514,000,000	\$45,000,000
Capital Cost (Current Dollars)	-\$671,000,000	-\$600,000,000	-\$748,000,000
Capital cost (Inflated)	-\$870,000,000	-\$594,000,000	-\$976,000,000
Reduction in GHG emissions below 1990 in CRD (tonnes/year)	378,000	404,400	367,500
Reduction in GHG emissions below 1990 in CRD (%)	23%	25%	23%
Electricity energy saved and produced (GWh/year)	116	129	124
Electricity saved and produced (\$)	\$6,000,000	\$12,000,000	\$6,000,000
Fossil fuel displaced - vehicle fuel (litres/year)	28,405,000	30,590,000	26,220,000
Input Variables - Revenues	Chosen Values	Optimistic Values	Pessimistic Values
Purchase price of electricity (\$/kWh)	\$0.065	\$0.060	\$0.080
Selling price of "green" electricity (\$/kWh)	\$0.077	\$0.100	\$0.038
Price of natural gas (\$/GJ)	\$12.000	\$14.000	\$10.000
Price of natural gas, after accounting for efficiency (\$/GJ)	\$17.647	\$20.588	\$13.333
Discount of district heating below this price	-15%	-10%	-20%
Retail price of green vehicle fuel (\$/litre)	\$1.10	\$1.20	\$1.00
Discount of vehicle fuel below the current price	-15%	-10%	-20%
Price of reclaimed water (\$/m3)	\$0.29	\$0.58	\$0.14
Value of Carbon Credits (per tonne)	\$30	\$40	\$0
Revenues from tipping fees (per tonne)	\$84	\$120	\$84
Input Variables - Financials			
Real Discount Rate	8.00%	5.00%	15.00%
Annual Population Growth Rate	0.70%	1.40%	0.50%
General Inflation Rate	1.90%	1.00%	3.00%
Gross Inflation Rate for Electricity	0.93%	2.50%	0.93%
Gross Inflation Rate for Vehicle Fuel	1.90%	4.73%	1.90%
Gross Inflation Rate for Heating Fuel	1.90%	8.06%	1.90%
Gross Inflation Rate for Natural Gas	1.90%	4.66%	1.90%
Gross Inflation Rate for Reclaimed Water	1.90%	3.00%	1.00%
Gross Inflation Rate for Greenhouse Gas Credits	1.90%	3.00%	1.00%
MFA Financing Rate	5.07%	4.50%	5.50%
Annual Construction Inflation Rate	10.00%	-10.00%	12.00%
Amortization Period	30yrs	30yrs	30yrs
Project Start	2010	2009	2011
Project End	2065	2065	2065
General Construction Contingency	15.00%	5.00%	25.00%
Input Variables - Costs			
Treatment Plant Costs - Base	\$495,000,000	\$473,000,000	\$525,000,000
Construction start	2009	2009	2011
Construction end	2011	2010	2012
Resource Recovery Infrastructure Costs - Base	\$175,500,000	\$126,500,000	\$223,100,000
Construction start	2009	2009	2011
Construction end	2015	2010	2012
Biogas absorption duration	6yrs	5yrs	7yrs
District heating absorption duration	7yrs	6yrs	10yrs
Input Variables - Physical			
Methane content of raw biogas	65%	70%	60%
Cogeneration efficiency (electrical)	35%	40%	30%
Winter sewage flow rate, October-March (m3/day)	118,500	130,000	110,000
Annual sewage flow rate (m3/day)	104,903	110,000	130,000
Average winter sewage temperature, October-March [C]	17.25	16	18
Average summer sewage temperature, April-September [C]	21.25	20.00	22.50
Low temperature of water leaving heat pumps [C]	4.00	3.00	5.00

Mechanical/electrical efficiency of heat pumps	78%	79%	75%
Percentage of available winter energy used	95%	100%	80%
Percentage of available summer energy used for domestic hot water	18%	20%	16%
Ratio of demand for cold vs. demand for domestic hot water	95%	100%	90%
Percentage of water reclaimed	16%	30%	10%
Kilometres of heating network required	20	10	50
Kilometres of reclaimed water piping required	30	20	50

Business Case Risk Analysis

It was not possible to undertake a detailed risk analysis within the time and budget available. Notwithstanding, we set out below a preliminary assessment of risk. For each aspect of risk its nature is described, the probability of it happening is rated, as are the severity of possible consequences should the item happen. Mitigation steps possible or undertaken are also noted.

The reader is also referred to the *Sensitivity Analysis* section starting on page 142 as this reviews input items to the model and evaluates the extent to which these assumptions the fact of the conclusions. Comment is also provided on challenges to implementing IRM in *Potential Challenges of an IRM Approach* on page 49.

Table 17: Preliminary risk assessment.

Aspect	Comment
Modeling risk	<p>Nature: Error in calculating or creating formulae, poor or incorrect assumptions, inadequate or incorrect data etc.</p> <p>Probability: Low to moderate.</p> <p>Severity: Moderate to high.</p> <p>Mitigation: Partially mitigated. Exposure and review by knowledgeable key members of the project team, combined with peer review and cross-checking has reduced the possibility of error combined with using quality legitimate sources for entries.</p>
Methodology	<p>Nature: Use of an appropriate methodology to assess IRM.</p> <p>Probability: Low.</p> <p>Severity: Low to moderate.</p> <p>Mitigation: Mitigated. The methodology follows international standard best practices that were reviewed by international valuation experts. It is consistent with provincial policy.</p>
Construction & implementation risk	<p>Nature: The possibility that construction costs are underestimated and/or that IRM design/delivery is affected by technology.</p> <p>Probability: Low.</p>

Aspect	Comment
Revenue projection risk	Severity: Low.
	Mitigation: While more mitigation work is desirable, the risk of this impacting the study is considered low.
	<p>The most recent construction cost inflation estimates have been embedded in the financial calculations and additional contingents have also been added, exceeding those normally used in the real estate market. Costs were estimated based on known existing installations, and the final model made generic to accept a variety of different technologies without being dependent on any single one of them. As a cross check, a supplier was contacted and an estimate obtained that approximately confirmed an engineer's professional cost estimate.</p> <p>Implementation risk is considered lower than a more traditional alternative due to the generic nature of the schematic design.</p> <p>Even a 100% cost overrun may still cost less than the traditional alternative since no deductions were adjusted for contributions by developers. Based on proven examples, implementation could take twice as long as is projected and still be delivered faster than the traditional approach.</p>
	<p>Nature: Revenues are not obtained as projected or are not obtained quickly enough.</p> <p>Probability: Moderate.</p> <p>Severity: Moderate.</p> <p>Mitigation: IRM would need to fail on construction costs and methodology as well as fail to achieve projected revenues for traditional approaches to be chosen over an IRM approach. Nevertheless, more work is desirable to profile the revenue cash flow and confirm the projections are achievable.</p> <p>Some conservative steps were taken in the S-Curve for revenues to help mitigate this risk, <i>i.e.</i>, it was not assumed that revenues would be received quickly in most cases. Support for the S-Curves were based on experiences elsewhere, <i>e.g.</i>, Sweden. Other steps taken are also conservative, for example no government grants or subsidies have been assumed in this analysis, nor has it been assumed that any contributions would be obtained from new development. These are somewhat unrealistic assumptions but act to make the cost and revenue estimates conservative.</p> <p>For the revenues to be achieved, careful management of implementation and policy will be required. Mitigation of this risk is thus long term and somewhat complex, but would not</p>

Aspect	Comment
Public risk	<p>affect choice of the IRM approach.</p> <p>Nature: Possibility that the public will not accept this approach</p> <p>Probability: Low to moderate.</p> <p>Severity: Moderate to high.</p> <p>Mitigation: Emphasis on good communications, combined with undertaking pilot projects.</p> <p>We anticipate that the public will be concerned whether IRM will increase odours and due to construction in existing neighbourhoods, objections to this shift. We expect that communication of the sustainable nature of this approach, combined with the substantially reduced tax burden and fact that IRM is less likely to create over than a more traditional approach, should assist in mitigating this risk.</p> <p>An additional mitigation strategy is to implement pilot projects to demonstrate the impact of IRM.</p>
Policy, professional & government risk	<p>Nature: Possibility that bureaucratic inertia and existing policy barriers cannot be adequately resolved.</p> <p>Probability: Low to moderate.</p> <p>Severity: High.</p> <p>Mitigation: Strong and clear political commitment to IRM, with clear leadership and advocacy, backed by an enabled and properly funded project office and leadership.</p> <p>IRM may appear threatening to many whose business relies on an existing traditional approach, whether in government or outside. Any systemic change is susceptible to a "death of 1,000 cuts" through bureaucratic inertia and this can only be mitigated by clear leadership, funding and implementation.</p>

While other risk aspects exist, they mostly pertain to more detailed aspects of the IRM model. Probably the most difficult risk to mitigate is that of political, professional and bureaucratic inertia, combined with the pressure of substantial existing commercial commitments.

Appendix I: Reviews and Comments

Synopsis of Expert Review Comments

Expert comments were received on the first draft of the report, which was distributed in early October, 2007 to expert reviewers, whose comments resulted in revisions to the first draft, as determined by the Study Team. We greatly appreciate and wish to thank the following people for their kind cooperation in reviewing the draft:

- Dr. David Bagley, PEng, Department Head and Associate Professor of Civil and Architectural Engineering, University of Wyoming
- Oliver Brandes, Associate Director and Water Sustainability Project Leader, POLIS Project on Ecological Governance, University of Victoria
- Peter Clark, FRICS, AACI P.App.
- Blair McCarry, PEng, LEED™ AP, Principal, Stantec, Vancouver
- Bob Landell, LEED™ AP, Principal, Avalon Mechanical Consultants Ltd., Victoria
- Les McDonald, R.P. Bio. Water Quality Biologist, Senior Impact Assessment Biologist (ret'd). Cranbrook, BC.
- Scott Muldavin, CRE, FRICS. President, The Muldavin Company Executive Director, Green Building Finance Consortium. San Rafael, CA
- Dr. Valerie Nelson. Coalition for Alternative Wastewater Treatment, Gloucester, MA
- Dr. Vladimir Novotny. CDM Chair Professor and Director, Center for Urban Environmental Studies. Northeastern University. Boston
- Dr. John Robinson. Institute for Resources, Environment and Sustainability. University of British Columbia
- Bruce Sampson. Vice President of Sustainability, BC Hydro
- Dr. Jerry Stonebridge, President- National Onsite Wastewater Recycling Association (NOWRA) Stonebridge Environmental Services, Freeland, WA
- John Thomas. Executive Director Washington Onsite Sewage Association (WOSSA) Tacoma, WA

General Comments

“I found the report to be detailed, thorough and impressive in scope and coverage. Virtually all of the issues that I think need to be addressed (technical aspects, financial analysis, environmental consequences, social and institutional dimensions, risk, etc.) are handled very well.”

“Quite an amazing document – well done.”

“...fine work here – this is well reasoned and outlines an innovative opportunity.”

“...very impressive and ambitious work given the number of inputs and assumptions needed to develop an estimate. Lots to really like...”

“...I strongly agree with the concept of interconnectivity of the treatment plants proposed in the IRM.”

“Generally...it is inappropriate for public agencies to think like businesses, they have different measures of success and failure...the decision-framework for these kind of public decisions—or even property investment involve both a financial model of some sort... A proper decision can only be made by looking at the modeled results with a full understanding of the risk inherent in key assumptions.”

Merits of IRM

“Benefits of IRM solutions:

- lower costs for water supply – efficiencies, re-use
- lower costs of maintaining existing infrastructure
- lower costs for new infrastructure
- greater resilience
- more flexibility to adapt to change
- ecological restoration
- resource efficiencies
- community benefits
- private financing
- international competitiveness
- better conservation of energy
- better use of assimilative capacity of the local environment”

“One of the biggest advantages of the IRM plan is...smaller cluster treatment plants utilises gradually, and in a more ecologically sound way, the waste assimilative capacity of the receiving water bodies that may be improved by incorporating wetlands and ponds with blended stormwater.”

“...You can tailor the IRM sub-units to treat the quality and quantity produced in each sub-watershed or community. The quality of the wastewater will change drastically by what establishments are discharging into the waste stream – Residential, Commercial, Industrial.”

Weaknesses of the Draft Report

“The connections with energy generation potential are very well made, but the integration with water supply, stormwater, recharge, etc. are not so well made.”

“... you can emphasize more clearly and directly that the IRM approach you are outlining is not a technical challenge.”

“The details of the capital cost estimations for the treatment facilities were not readily available (or I missed them). How sensitive is the overall capital cost to a change from, say, the cloth media filter, to an ultrafiltration system? Perhaps not much at all in the entire IRM system but the transparency of this is missing.”

“The sensitivity analysis is relatively simplistic. I understand the limitations involved and so a full-blown sensitivity analysis using Monte Carlo techniques (to develop probability distributions as well as determine sensitivity) is not yet appropriate (although it may be in further study). What I would have liked to see more clearly, however, is whether the results are sensitive to big impacts.”

“I believe you are ... underestimating the cost of the built infrastructure... I suspect your distributed system will have higher built costs -- but the benefit is they can provide a future revenue stream that maybe significant.”

“...IRM approach is not really about the technical... but the issues of who pays – who benefits is significant. This social context is critical.”

Suggested Additions

“The report would be greatly strengthened [by] a clear description of what your technology solution would look like (as the alternative to the traditional approach). An outsider to the field ...would probably like a visual story of both what the conventional solution would be ... and also a visual story of this new model”

“The issue of manpower, maintenance, etc should be discussed.”

“...have a few pages of the key assumptions that are assumed to be true in order for the financial results to be valid.”

“...a single financial graph showing cash flow or similar over the construction period with revenues indicated. It appears that the proposed option would cost less to build and significantly less to operate. Some milestone cost summaries at say 5, 10, 15 and 20 years might be good.”

“The heating and cooling section requires a clear diagram.”

“...you are very clear that without a significant change in the way decisions are made... you would get very different results... Analogies showing where old process was used and resulted in a less than optimal societal result would be very compelling.”

“Identifying risks and letting the reader understand the risks will be more ...It would be great to have a list of the key concerns.”

“More on the comparative speed of implementation would be very important up front.”

Paraphrased: In the 1970's and 80's (BC) Environmental Protection favoured and encouraged a few large plants because the smaller plants were less reliable and less likely to have trained operators. This issues may no longer be valid but they should be mentioned and explain how technology has overcome them.

“Include a communications plan and information packages where some simplification will be desirable for a wider audience.”

Questions to be Addressed in Next Phase

“Perhaps the key technical question for decentralized wastewater treatment is whether effluent quality targets can be achieved...the specific capability to achieve any given standard must be tested... it is appropriate to assume that pilot testing will lead to a detailed design that can achieve the different effluent criteria...”

“A comprehensive TMDL (Total Maximum Daily Load)-type plan must be developed that would be a cornerstone of the entire plan. The type of effluent reclamation will be closely related to the use of the reclaimed water.”

“An optimization plan based on a rather complex model should be developed that would optimize the size of the treatment plants and the required removals.”

“...need to have all the criteria for siting these IRM plants in a triple bottom line decision tree so all the communities feel like they are being treated equally.”

“One of the weakest links in the US is in the training and capacities of the designers and installers.”

Shoddy installation has been the downfall of many projects in the US, which hurts the reputation of the whole field... What is the telemetry or monitoring system that would be put in place? How much does all this long-term maintenance and management cost?"

"Carry out preliminary ...research with road work departments of municipalities, Terasen, Telus, and other organizations who routinely excavate...streets, to determine how to best coordinate with District energy piping."

"Carry out some preliminary market research with large consumers, concerning their willingness to incorporate District Energy into their plants."

"People are willing to pay more if they perceive a value in the product -- but what do people perceive as "value" in this case?"

"New infill development could be privately installed and managed? What are the financing implications? Who pays for what and who benefits from what? Does each neighbourhood installation float on its own? Or, is there a District-wide tax or water/sewer rate? How are the benefits of the energy recapture distributed?"

"What will be the monitoring requirements? Who will conduct monitoring? Who will provide maintenance in the event of a technical failure?"

"Talk about the social responsibilities of the citizens to the environment that they live in...stewards of their land."

"Suggestion for ... additional work is a strong focus on the institutional dimensions of implementing such an approach."

"The major barriers to more sustainable practice are not usually technological or economic but institutional. If the codes, standards, job descriptions, performance criteria, professional requirements, etc. militate against the changes in procedures and practices required, then the availability of low cost alternatives that are technically feasible and environmentally and socially desirable is not sufficient to change practices. A serious analysis is needed of the kinds of institutional changes in reward systems and standards that are required."

"Issues around governance and public accountability/oversight cannot be addressed in detail in this report, but it should be made clear that these issues will be addressed (in the next phase?)"

"The current regulatory framework in BC is one premised on a regime of creating risk certainty -- the approach you are advocating would require a different perception of risk (and how that risk is to be managed). Ultimately the kind of management change you are proposing would need to be complemented by an evolution in regulation that emphasizes innovation and addresses risk."

"The unique aspect of this approach is integration and more explanation on this and the impact of a shift to an integrated approach would be welcome."

Research Needs

“The principles applied in development of IRM list a typical optimization problem, *i.e.*, which is the best use of the by products of the IRM, *i.e.*, what would be the most optimal uses of the reclaimed water, organic waste, etc. The state of the art is not yet well developed and there is a need for more research. It is understood that the project design typically cannot incorporate extensive fundamental research, especially in cases where the state of the research seems to be behind the ideas.”

“...research should develop and test the wetlands and ponds that would be designed for blending of the treated effluents in combination with stormwater and provide storage for reclaimed water for further reuse.”

“Including stormwater into the heat balance has a high degree of uncertainty and I agree that this should be a subject of modeling research.”

“Seattle and San Francisco are developing models for integrated capital budgeting across the bureaucracies...use these inter-agency pilots as models for what could be done city-wide.”

“More research on traditional public cost-benefit analysis is needed.”

“...ultimately... management change... would need to be complemented by an evolution in regulation that emphasizes innovation and addresses risk by changing the onus and evidentiary hurdles on key aspects.”

“The one aspect that I believe will make or break this project is the “social” analysis in the triple bottom line. What we have seen in the past in the [US] states is that when communities look at water, wastewater and stormwater, they first look at what is it going to cost me? and second, how is it going to effect my daily life? Now because of climate change, some have widened their horizons to look at the bigger picture, but this will not be the deciding factor with the general populace.”

“Those who...read... this report will immediately recognize that the implications of any redesign to integrated waste disposal is clearly going to result in a major change management exercise and some thoughts on this, or further study to assess likely impacts on all sectors, is desirable.”

Overall Conclusions

“Integrated resource management is appropriate for British Columbia and its smaller sub-jurisdictions.”

“I consider the Integrated Resource Management (IRM) approach to be conceptually sound, both technically and financially. The idea to examine the water and waste systems of a municipality as a holistic unit follows sound industrial ecology concepts, in particular that mass is recycled due to energy flow through a system.”

“Decentralized wastewater treatment using effectively off-the-shelf technology could indeed achieve effluent quality targets.”

“The IRM plan is a realistic and revolutionary plan implementing the new fifth paradigm of urban drainage and wastewater management that, if realized, will dramatically change the way urban drainage and wastewater disposal has been carried out. The plan, when combined with landscape best management practices can bring significant savings and actually be profitable.”

“Following the concept of the total urban hydrological cycle, the IRM system will provide ecological flow for supporting aquatic life in flow deprived urban streams, which in some instances may be desperately needed, and also water for other uses such as irrigation or flushing.”

“Overall, the system is sound and resilient.”

“The business case is more than sufficiently proven in the report to demonstrate the benefits and opportunities to BC and those associated with the management of waste resources in industry and government which could be significant both domestically and in the wider international arena.”

“The report identifies opportunities that can provide both a better way for society to manage waste and, more importantly, of demonstrating government leadership in solving problems confronting developed industrial nations as well as showing options for the developing nations... There is a strong case for further exploration of your [IRM] model even if the financial costs are determined to be equivalent to the existing systems. This is clearly sound public policy.”

“Public policy and the role, responsibility and accountability required of our governments is clearer than ever before. Where a more effective technology is available coupled with a financial benefit, it would be irresponsible for any government not to pursue the science and economics of either a new approach or the modification of an existing methodology.... It is obviously the smart thing to do. This is the proactive and positive approach.”

“If Victoria demonstrates this approach, then this model of localized wastewater/energy infrastructure could become an international leading edge standard.”

“If the technical details of the analysis hold up... then I fully agree with the conclusion that the analysis suggests that this is definitely worth pursuing to the next level, and justifies further such work.”

“I would encourage all those involved with the development and production of this report to consider carefully the implications from the conclusions. If the estimated impact on GHG reduction is accurate, this is too important not to be communicated to a far wider global audience. The report must be completed.”

“Those responsible for developing policy related to the analysis of, and reporting on, the effects of green house gas emission in public and private projects should find this report of considerable benefit... as it takes the clear step of accounting for GHGs and including the considerations in the business case.”

“Anything that challenges the status quo or can be classified as a change in thinking is generally first met with indifference and even skepticism. The challenge is to find someone who is prepared to champion something that might be seen as a threat to the system and existing standard of practice.”

Note that this preliminary study shows many areas where extra research is required, but that this is not the primary current focus. Information has been kindly provided for the proposed CRD sewage system, to help in providing a base line analysis and comparison for an IRM approach and we are grateful for CRD's support, input and cooperation, and their consultants.

The accuracy of cost estimates is consistent with the requirements of a conceptual study, and a detailed design process is required to refine the cost estimates for wastewater treatment and resource recovery infrastructure in a given community.

Appendix J: Aspects for Further Study

The Study Team identified the following questions concerning Integrated Resource Management in general, which deserve further study.

Governance Structure

- What governance structure will be most effective in implementing an IRM model at the local government level? In Sweden for example, individual municipalities own local energy and transportation companies, in addition to companies responsible for solid and liquid waste. These publicly owned firms are required to cooperate in order to find the highest and best use & value of waste, and the resulting revenues benefit taxpayers. Could a similar model work here? The City of Hamilton, for example, has formed a local energy utility.

Barriers to Implementation

While researching the technologies available for IRM and their costs, it became clear to the Study Team that there are no physical or economic barriers to implementing IRM. The technology is stable, and the economic returns make implementation viable. There are some advantages of a traditional more centralised approach over IRM, including streamlined administrative effort to plan and implement treatment facilities.

- Building codes, codes of practice, standards, job descriptions, performance criteria, professional standards, and liability must be addressed in order to bring current practice into line with current technologies.
- Significant changes are required in order for line staff of various provincial Ministries, regional districts and municipalities to support and encourage IRM. At present, staff have a mandate to ensure compliance with existing legislation and regulation, but often are not encouraged to support innovation.
- Government policy and procedure will have to shift to accept a higher level of risk. The private sector, while a critical component of the IRM model, must see support from all levels of government before it will accept significant risk. One of the most significant perceived risks is the fear that bureaucrats will delay decision-making, in itself creating significant costs, until a project is forced to adopt traditional, less economically viable approaches. Red tape, a lack of integrated policies that are in step with innovative practice, and government culture are seen as a potential barrier to innovation.

Sewage Treatment Options

- The best way to make the distributed treatment plant network as robust as possible, resistant to severe weather (including peak wet weather flows) and to equipment failures must be further assessed. This work could be carried out using Monte Carlo computer simulations, Failure Modes and Effects Analysis, and Mean Time Between Failure Analysis.
- The costs and benefits of investing in strategies to prevent peak wet weather flows, must be compared with the cost of handling those flows with higher-capacity treatment plants. In other words, is it more cost-effective to prevent inflows and infiltration of stormwater into the sewage network through source control?
- Given that many municipalities in B.C. face significant costs to replace aging sewer infrastructure, to what extent can the IRM approach reduce these costs?
- Revenues from recovered resources exceed costs in the IRM approach, as modelled on the Capital Region. Are the economics also favourable for cities which would need to retrofit existing sewage treatment infrastructure? Should these cities replace existing treatment infrastructure today, or replace it with an IRM approach as equipment becomes obsolete?
- Since sewage infrastructure will need to be replaced over time in any case, will it be more or less difficult to implement IRM in an established community versus a new one?
- Since the IRM approach will generate revenues which exceed the cost of sewage treatment and resource recovery infrastructure (please see *Conclusions*), to what extent can these revenues be applied to replacing aging sewage infrastructure, and to retiring the debt on the capital expenditures for treatment and resource recovery? What will be the net benefit to taxpayers?
- What design strategies can reduce the electrical energy consumption of sewage treatment plants?
- What opportunities exist for co-locating small treatment plants within existing commercial buildings in the Capital Region?
- How can new financial models be used to resolve the ‘false economy’ created by segregated capital and operating costs?
- A “catchment level” analysis should be performed whereby several catchments (preferable real cases), representing a cross-section of urban density, existing infrastructure conditions, resource clients and natural environmental conditions are examined in some detail in order to estimate:
 - The optimum mix of final dispositions for recovered water;
 - The natural assimilation capacity for the catchment and the types of assimilation systems that can be employed;
 - Collection system modifications (including I&I control measures) that would be economically justified under the WERC model and the accompanying costs;

- Inter-WERC network connections and contingency measures- types, sizes and configurations of connections, applicability of modern trenchless technologies;
 - Siting and configuration of the WERC plant;
 - Impact of having local WERC plant on future in-catchment collection system maintenance and development costs—are there savings?
 - Impact on downstream infrastructure—what can be retired or derated and what are the long-term cost implications?
 - Detailed site-specific cost estimate for the required infrastructure;
 - A catchment level resource flow diagram;
 - Implementation strategies; and,
 - Assessment of resource markets, regulatory changes required to allow implementation and degree of public acceptance.
- Detailed hazard identification and mitigation plans will be required to ensure public health and safety regarding treatment plants and resource recovery infrastructure.
 - Detailed study will be required to ensure that the temperature of reclaimed water which is used to recharge creeks is compatible with the requirements of the receiving ecosystem. This temperature can be adjusted by balancing the amount of heat energy and cold energy which is reclaimed from the water through heat pumps.

District Heating and Cooling

District heating piping could be co-located with other services (reclaimed water, stormwater, telecommunications, etc.) which could lower the overall cost of building the network.

- The costs and benefits of this idea will need to be examined with municipalities and utilities who routinely excavate streets.
- Until heat pumps reach their full capacity, a district heating network could use heat from cogeneration (described below). Heat from this source is free, and the savings to an IRM model could be evaluated.
- The IRM model could be refined to determine the best number and distribution of heat pumps, in order to optimise overall costs and benefits of district heating and cooling.
- As inflow and infiltration (I&I) of sewage pipes in the Capital Region decreases over time, the average temperatures of sewage will rise: infiltration water in winter is colder than sewage from homes and business. This relationship can already been seen from the fact that I&I for average raw sewage flows through the Clover Point outfall is lower that the I&I for Macaulay flows, and

the average winter temperature of Clover Point flows is higher.⁹⁴ This small but significant difference means the proportion of the region's heating requirements which could be met through sewage-source heat pumps will increase over time.

- The analysis does not take into account stormwater, which is another potential source of heat energy.
- Heat pumps can be operated in a cascade fashion in order to increase their performance and reduce energy costs. The costs and the benefits of this operating strategy should be modelled in a future study.
- Since cogeneration will provide heat energy throughout the year, it will be valuable to analyse the economics of using adsorption refrigeration from cogen heat to provide air conditioning in the summer.
- Government and other organisations could include clauses in their technical standards for new buildings and renovations to require that new hydronic heating systems be compatible with a maximum supply temperature of 55°C for primary water.
- A detailed model for local energy districts could be created, including:
 - large existing heating plants in each area
 - their relative locations and inter-connection potential
 - remaining life of their respective boilers chillers and other significant components
 - technical suitability (for example, steam systems are generally not suitable)
 - summer and winter loads

Energy Generation from Organic and Other Wastes

The IRM model only takes into account volumes of organic waste which are currently measured in the Capital Region, including those which are accepted by the regional landfill or diverted to composting. Future modelling could research increases in this supply, which could for example be influenced by steering policies to encourage energy crops such as grass or salix. The municipalities could become a greater source of biomass such as backyard compost. Would citizens be willing, for example, to send more of their organic waste to curb side collection for biogas production, if they appreciated that their actions would help run buses and reduce greenhouse gas emissions?

- Further economic analysis is needed to find the most effective ways to encourage source separation of waste.

⁹⁴ 2003 Compliance Monitoring for Sewage Outfalls Operated by the Capital Regional District of British Columbia, Canada. Capital Regional District

- Further modelling is needed to understand how to optimise the reduction in total greenhouse gas emissions. Is the highest and best use & value of biomethane as greenhouse-gas neutral fuel for buses and cars, or for the production of electrical energy?
- Plastics represent a potential source of energy through gasification. In the model, plastics have been included in the fuel inputs for the gasifier, although in practice doing so will rely on first ensuring that gasification of plastics will not result in harmful emissions. Incineration of municipal solid waste is common in Europe, but has not been included in the IRM model. Further study is needed to understand the costs and benefits of thorough separation processes for plastics, versus simply recycling the material itself rather than its embodied energy.
- If syngas/cogen and heat pumps can be co-located, syngas can be used to significantly boost influent temperature and heat pump efficiency.
- The highest value of syngas and biogas may not be as fuel, but rather as feedstock to the petrochemical industry, as a replacement for fossil-based feedstock.⁹⁵
- The economics of recovering metals from gasifier residues should be examined.

Value, Business Case & Economic

Business case models for IRM need further development, and will be affected by IRM's underlying economics:

- The primary issues relate to refinement of the market. Assuming IRM is implemented, we expect the market prices of both revenues and costs to change. This may tend to limit for example, tipping fees, which are currently derived in many locations from government cost-recovery charges rather than market competition. This will likely affect both costs and revenues and thus, more work, including monitoring systems and regulatory/oversight impacts, will require to be developed further;
- The current model includes assessment of ecological aspects in a crude way, based on how carbon credits and taxes are expected to work. Firstly, this will vary as these items are implemented but secondly and more importantly, there is an inequity in accounting for some items such as GHGs (*e.g.* carbon credits are at say \$30/tonne, but there is no distinction between carbon dioxide and methane, yet the latter is 21 times more harmful as CO₂).
- More work is needed to understand broader ecological and GHG metrics, for example to measure heat output. Since global warming is impacted by heat, and this item is rarely evaluated as part of business cases, starting to track items like this and create value-equivalent proxies may not only help with climate action initiatives and understanding but also in changing behaviours towards more sustainable decisions.

⁹⁵ New Scientist, July 7-13, 2007, Who needs oil?

Motions approved by the CRD Board Regarding Pilot Projects:

Saanich Peninsula Wastewater Commission (*January 13, 2016 Board Meeting*)

That the Saanich Peninsula Wastewater Commission seek support from the Capital Regional District (CRD) Board for a pilot program to handle Biosolids at the Saanich Peninsula Wastewater Treatment Plant that is in line with CRD Board Policy.

Environmental Services Committee (*December 9, 2015 Board Meeting*)

That staff be directed to report back on a priority basis on options for an in-region kitchen scraps processing pilot.